

Autonics

TEMPERATURE CONTROLLER TZN4H SERIES

M A N U A L



Thank you very much for selecting Autonics products.
For your safety, please read the following before using.

Caution for your safety

- *Please keep these instructions and review them before using this unit.
- *Please observe the cautions that follow:
- Warning** Serious injury may result if instructions are not followed.
- Caution** Product may be damaged, or injury may result if instructions are not followed.
- *The following is an explanation of the symbols used in the operation manual.
- Caution:**Injury or danger may occur under special conditions.

Warning

- In case of using this unit with machineries(Nuclear power control, medical equipment, vehicle, train, airplane, combustion apparatus, entertainment or safety device etc), it requires installing fail-safe device, or contact us for information on type required.**
It may result in serious damage, fire or human injury.
- This unit must be mounted on panel.**
It may give an electric shock.
- Do not connect terminals when it is power on.**
It may give an electric shock.
- Please check the number of terminal when connect power line or measuring input.**
It may cause a fire.
- Do not repair or checkup when power on.**
It may give an electric shock.

Caution

- This unit shall not be used outdoors.**
It might shorten the life cycle of the product or give an electric shock.
- When wire connection, No. 20AWG(0.5mm²) should be used and screw bolt on terminal block with 0.74N·m to 0.90N·m strength.**
It may result in malfunction or fire due to contact failure.
- Please observe specification rating.**
It might shorten the life cycle of the product and cause a fire.
- Do not use the load beyond rated switching capacity of Relay contact.**
It may cause insulation failure, contact melt, contact failure, relay broken fire etc.
- In cleaning the unit, do not use water or an oil-based detergent.**
It might cause an electric shock or fire that will result in damage to the product.
- Do not inflow dust or wire dregs into inside of this unit.**
It may cause a fire or mechanical trouble.
- Do not use this unit at place where there are flammable or explosive gas, humidity, direct ray of the sun, radiant heat, vibration, impact etc.**
It may cause a fire or explosion.
- Please check the polarity of power before connecting thermocouple sensor.**
It may cause a fire or explosion.

Front panel identification

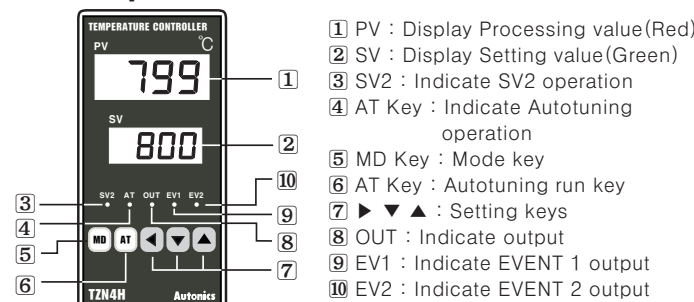

*The above specification are changeable without notice anytime.

Ordering information

	TZN	4	H	1	4	R
	①	②	③	④	⑤	⑥
① Item	TZN Temperature PID					
② Digit	4 4 Digit					
③ Size	H DIN W48×H96mm					
④ Sub output	1	Event 1 output				
	2	Event 1+Event 2 output				
	R	Event 1+Retransmission output(PV:4-20mADC)				
	A	Event 1+Event 2+Retransmission output(PV:DC4-20mA)				
	B	Event 1+Event 2+RS485 communication function				
⑤ Power supply	4	100-240VAC 50/60Hz				
	R	Relay output				
	S	SSR output				
⑥ Control output	C	Current output(4-20mADC)				

*All models has EV-1 output.

Specifications

Series	TZN4H		
Power supply	100-240VAC 50/60Hz		
Allowable voltage range	90 to 110% of rated voltage		
Power consumption	Approx. 6VA		
Display method	7Segment LED display [Processing value(PV):Red, Setting value(SV):Green]		
Input sensor	Thermocouple:K(CA), J(IC), R(PR), E(CR), T(CC), S(PP), N(NN), W(TT)(Tolerance line resistance is max. 100Ω) RTD:DIN Pt100Ω, JIS Pt100Ω, 3 wires type (Tolerance of line resistance is max. 5Ω per a wire) Voltage:1-5VDC, 0-10VDC, Current:4-20mADC		
Control method	ON/OFF Control P, PI, PD, PIDF, PIDS		
Control output	Relay contact output:250VAC 3A 1c SSR output:12VDC ±3V Max. 30mA Current output:4-20mADC(Load resistance:Max. 600Ω)		
Retransmission output	PV retransmission:4-20mADC(Load resistance:Max. 600Ω)		
Communication function	PV retransmission, SV setting		
Sub output	Event 1, 2 output:Relay contact output 250VAC 1A 1a		
Display accuracy	±0.3% based on F·S or 3°C Max.		
Setting type	Setting by front push buttons		
Hysteresis	Adjustable 1 to 100(0.1 to 100.0)°C at ON/OFF control		
Alarm output	Set interval between ON and OFF for alarm output from 1 to 100°C(Decimal type : 0.1 to 100.0°C)		
Proportional band(P)	0.0 to 100.0%		
Integral time(I)	0 to 3600sec.		
Derivative time(D)	0 to 3600sec.		
Control time(T)	1 to 120sec.		
Sampling time	0.5sec.		
LBA setting time	1 to 999sec.		
Ramp setting time	Ramp up, Ramp down at 1 to 99 minute		
Dielectric strength	2000VAC for 1 minute		
Vibration	Mechanical	0.75mm amplitude at frequency of 10 to 55Hz in each of X, Y, Z directions for 2 hours	
	Malfunction	0.5mm amplitude at frequency of 10 to 55Hz in each of X, Y, Z directions for 10 minutes	
Relay life cycle	Main output	Mechanical : Min.10,000,000 times Electrical : Min.100,000 times(250VAC 3A resistive load)	
	Sub output	Mechanical : Min.20,000,000 times Electrical : Min.500,000 times(250VAC 1A resistive load)	
Insulation resistance	Min. 100MΩ(at 500VDC)		
Noise strength	±2kV R Phase & S Phase 1μs		
Memory retention	10 years		
Ambient temperature	-10 to 50°C(at non-freezing status)		
Storage temperature	-20 to 60°C(at non-freezing status)		
Ambient humidity	35 to 85% RH		
Weight	Approx. 259g		

Selection switch for Input sensor/ Voltage/Current

*Please select the S/W of this unit by sensors.

A)In case of thermocouple input(K(CA), J(IC), R(PR), E(CR), T(CC), S(PR), N(NN), W(TT)) In case of RTD input(DPtL, DPH, JPL, JPtH)	S/W1 	S/W2 	S/W1 : 1 S/W2 : V
B)In case of voltage input(<1-5VDC, 0-10VDC)	S/W1 	S/W2 	S/W1 : 2 S/W2 : V
C)In case of current input(<4-20mADC)	S/W1 	S/W2 	S/W1 : 2 S/W2 : A

Input range for the sensor

Input sensor	Display	Selectable temperature range °C	Selectable temperature range °F
K(CA)H	ECrH	-100 to 1300°C	-148 to 2372°F
K(CA)L	ECrL	-100.0 to 999.9°C	This mode can not use as °F
J(IC)H	JICrH	0 to 800°C	32 to 1472°F
J(IC)L	JICrL	0.0 to 800.0°C	This mode can not use as °F
R(PR)	r Pr	0 to 1700°C	32 to 3092°F
E(CR)H	ECrH	0 to 800°C	32 to 1472°F
E(CR)L	ECrL	0.0 to 800.0°C	This mode can not use as °F
T(CC)H	ECrH	-200 to 400°C	-328 to 752°F
T(CC)L	ECrL	-199.9 to 400.0°C	This mode can not use as °F
S(PR)	S Pr	0 to 1700°C	32 to 3092°F
N(NN)	n nn	0 to 1300°C	32 to 2372°F
W(TT)	U LL	0 to 2300°C	32 to 4172°F
JPH	JPLH	0 to 500°C	32 to 932°F
JPL	JPL	-199.9 to 199.9°C	-199.9 to 392.0°F
DPH	dPLH	0 to 500°C	32 to 932°F
DPIL	dPL	-199.9 to 199.9°C	-199.9 to 392.0°F
0-10VDC	A--1	-1999 to 9999°C	-1999 to 9999°F
1-5VDC	A--2	-1999 to 9999°C	-1999 to 9999°F
4-20mADC	A--3	-1999 to 9999°C	-1999 to 9999°F

Autotuning operation

- PID Autotuning function automatically measures thermal characteristics and response of the control system and then executes its value under high response & stability after calculating the time constant of PID required to control optimum temperature.
- Execute the Autotuning function at initial time after connecting the controller & the sensor.
- Execution of Autotuning is started when pressing AT key for 3sec. or more.
- When the Autotuning is started, AT lamp will flicker, and when the lamp is OFF, this operation will stop.
- While the Autotuning function is executing, it is stopped by pressing AT key for 5sec. or more.
- When the power turns off or the stop signal is applied while Autotuning function is executing, time constant of PID is not changed and it remembers the value before power turns off.
- Time constant of PID selected by Autotuning function can be changed in first setting group.
- It has two kinds of Autotuning mode.
- Autotuning operation is executed at setting value(SV) in Tun1 mode which is factory default.
- Autotuning operation is executed at 70% of setting value(SV).
- Mode change is available in second setting group.
- Execute the Autotuning function again periodically, because the thermal characteristics for the control object can be changed when the controller is used continuously for a long time.

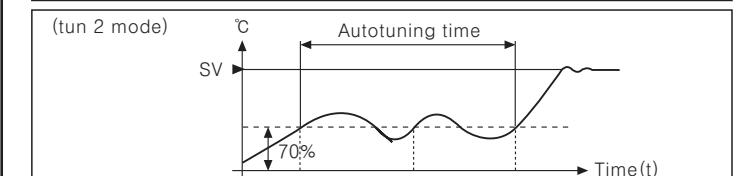
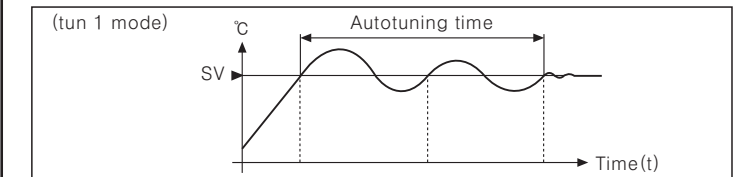

ON/OFF control

- ON/OFF control is called two position control because the output turns on when PV falls lower than SV and the output turns off when PV is higher than SV. This control method is not only for controlling temperature, but also it is basic control method for sequence control.
- If you set P value as "0.0" in first setting group, ON/OFF control will operate.
- There is a programmable temperature difference between ON and OFF in ON/OFF control(Hysteresis width), if difference is too small, then hunting (chattering) can occur. Temperature difference can be set in **HYS** position of first setting group. Setting range is 1 to 100°C(or 0.1 to 100.0°C).
- HYS** is displayed when P value is "0", but **HYS** will not be displayed, if P value is not "0".
- This ON/OFF control should not be applied when equipment(Cooling compressor) to be controlled can be damaged by frequent ON and OFF.
- Even if ON/OFF control is stable status, the hunting can be occurred by setting value in **HYS** or capacity of the heater or response characteristic of the equipment to be controlled or installing position of the sensor. Please consider above points to minimize the hunting when designing the system.

Dual PID control function

When controlling temperature, two types of control characteristic are available as below. One is when you need to minimize the time which PV reaches to SV as like(Drawing 1). The other is when you need to minimize overshoot even though the reaching(PV to SV) is slow(Drawing 2).

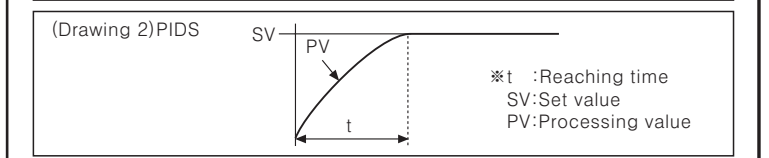
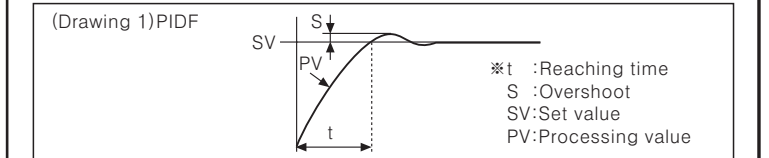

- There are high-speed response type and low-speed response type built in this unit. Therefore user can select each function according to their application.
- You can select dual PID control function in second setting group. It is selectable PIDF or PIDS in PIDt mode.
- PIDF(High-speed response type) : This mode is applied to machines or systems which require high-speed response.
Ex)Machines which must be applied preliminary heat before it operates
*Injection machine, an electric furnace, etc.
- PIDS(Low-speed response type) : This mode is applied at the machine which requires little overshoot.
Ex)Because a fire can occur by overshoot of the temperature.
*Plating machine to control temperature, oiling system to control temperature of oil, etc.
- Factory specification is PIDF in TZN series.
According to control system, please select mode.

Manual reset

- Proportional control has deviation because rising time is not same as falling time, even if the unit operates normally.
- Manual reset function is used at proportional control(P) mode only.
- If set **rESt** function in first setting group, the manual reset will run.
- When PV and SV is equal, Reset value is 50% and when control is stable, if the temperature is lower than SV, reset value should be higher and on the other hand, reset value should be smaller.
- rESt** setting method according to result of control

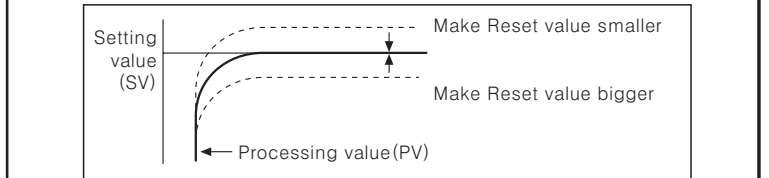

Control output

- There are 3 kinds of main output in this unit, such as relay output, SSR output, current(4-20mADC), but this unit has one main output only. Therefore please select one main output in ordering information according to your application.
- Relay output rated 250VAC 3A is indicated as "R"
- SSR output rated 12VDC ±3V is indicated "S", the load of over 30mADC can not use.
- Current output rated 4-20mADC is indicated as "C", resistive load can be used under 600Ω.
(Note)4-20mADC current output is different from 4-20mADC retransmission output.

Relay output

- Relay output is function for outputting ON/OFF for main control by using relay contact. It repeats ON/OFF the load in order to heat or cool continuously, in this case, driving magnet S/W or power relay(big capacity) with using relay contact of this unit.
- Do not exceed contact capacity of relay to adjust in unit specification, when use relay contact output. If relay is damaged, it may cause a fire.
- When it controls main relay or magnet switch with power relay contact, if flow reverse electromotive force from coil of power relay or magnet S/W into this unit, it may result in products damaged or output oscillated.
- Life cycle of relay(electrical/mechanical) is indicated in specification. Please design the system after checking the life cycle of relay.
If set "t" longer in first setting group, the life cycle of relay is getting lower. If it needs to set control period "t" shorter due to thermal response is fast, SSR output type should be used.

■ Voltage pulse output(SSR)

Voltage pulse output is to control SSR unit installed in out of this unit. Generally the capacity of relay contact is limited. If the capacity of relay is getting bigger, the life cycle will be shortened by noise or spark.

- SSR output is 12VDC and it can use max. 30mA for load.
- Response speed of SSR is faster than relay cause of using semiconductor, it can proceed high speed control.
- If set "t" shorter(1 to 2sec.), it will be good condition to control the target.
- Radiation of semiconductor is very important in SSR. Therefore it is likely use 80% of rated of SSR and if SSR is damaged, it may result in a fire.

■ Current output(4-20mADC)

This output, called analogue output is to control the transducer(SCR unit), it can proceed stable control because there is no a sudden change. It outputs 4-20mADC, manipulated value is 100% at 20mADC, 0% at 4mADC.

- It is used with transducer and can not be used as the other application.
- This output operates through inner separated a constant current-circuit. Therefore current output is not changed even if the resistive load is connected in outside, but if resistive load is too high(over 600Ω), the current can be changed. (Please use the resistive load less than 600Ω.)
- Do not use a current output in case of using ON/OFF control.
- When current output is used, it is changing as analogue form, the manipulated value can rarely be 100% or 0%.
- Therefore LBA function is not used.
- Front OUT lamp does not operates in case of using a current output.

■ Retransmission output(4-20mADC)

Retransmission output is different with current output of control output and to retransmit current(4 to 20mADC) converting the measuring temperature to the recorder, PC, etc.

But this current output can not use at over 600Ω resistive load.

- Mode of retransmission output is selected at FS-H, FS-L in the second flow chart.
- When PV reach at value of FS-L, it output 4mA.
- When PV reach at value of FS-H, it output 20mA.
- 4 to 20mADC is design as resolution of min. 16,000 divisions.

■ RS485 communication function

It is used on the purpose that transmitting PV to an external equipment, setting SV at the external equipment.

- It can be set at bps, Adrs in second setting group.
- bps setting : 2400, 4800, 9600(Start bit1, Stop bit1, Non parity)
- Adrs setting : 1 to 99
- Compatible PLC : LG, Mitsubishi, CIMON etc.

■ Decimal point(Dot) setting function

Decimal point is displayed as "dot" in second setting group when the input is only analog(0-10VDC, 1-5VDC, 4-20mADC).

■ Cool/Heat function

Generally there are two ways to control temperature, one(Heat-function) is to heat when PV is getting down(Heater). The other(Cool-function) is to cool when PV is getting high(Refrigerator).

These functions are operating oppositely when it is ON/OFF control or proportional control.

But in this case PID time constant will be different due to PID time constant will be decided according to control system when it is PID control.

- Cool-function and heat-function can be set at "o-FL" mode in second setting group.
- Cool-function and heat-function must be set correctly according to the application, if set as opposite function, it may cause a fire. (If set cool-function at heater, even if temperature is getting high, it will be maintained ON and it may cause a fire.)
- Avoid changing heat-function to cool-function or cool-function to heat-function on the unit is operating.
- It is impossible to operate both functions at once in this unit. Therefore one function should be selected only.

■ Ramp function

Ramp function is to delay the rising time or falling time of temperature. If you change setting value at stable state of control, it forces to rise or fall the temperature of control system during setting time at rAPU, rAPd in first setting group. **If rAmP is not ON in second setting group, rAPu, rAPd will not be displayed in first setting group.**

- Set rAmP is ON in second setting group for using Ramp function.
- Set the falling time and rising time in rAPU and rAPU mode of first setting group.
- Ramp function will be operating when changing the set value at stable control status or supply the power again after the power was removed.

※rAPU function(Delay of rising time)

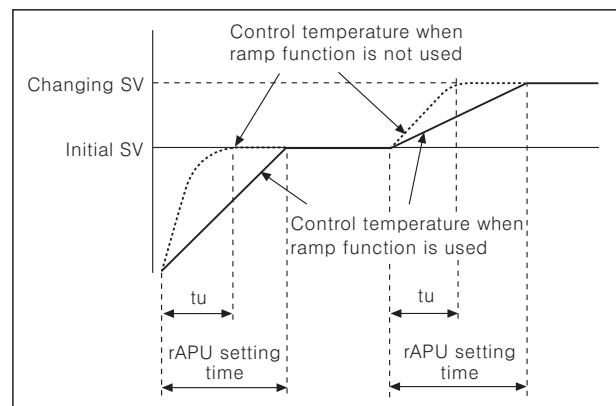

It makes delay rising temperature when change the set value at stable control status or delay the initial rising temperature as like above picture.

Note1)rAPu time cannot be set shorter than temperature rising time(tu), when Ramp function is not used.

※rAPd function(Delay of falling time)

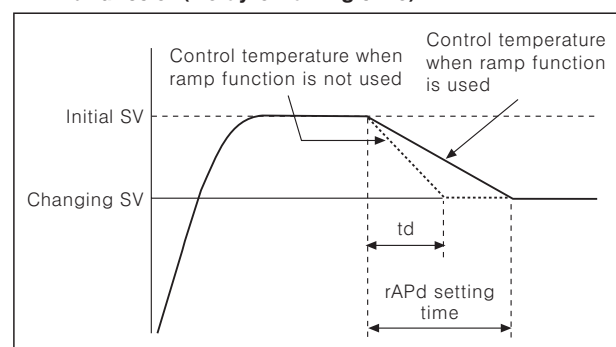

It controls falling temperature as above.

Note1)rAPd time cannot be shorter than falling time(td) of not being ramp function operated.

■ SV-2 function

If using SV-2 function, it changes the temperature of control system to the second setting value by external relay contact signal. It can change the setting value as sequentially by relay contact without key operation.

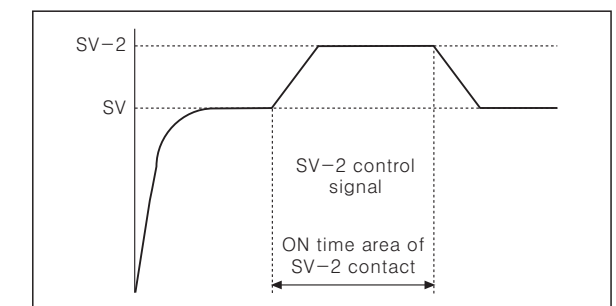

- It can set SV-2 at required time and particular area as the above chart.
- SV-2 is in first setting group.
- Application : The control system, which has to maintain constant temperature such as oven application. If you open the door, temperature will go down. In this case if you set the second setting value higher than setting value, temperature will rise fast. Therefore, after installing a micro-switch in order to detect the door Open/Close and connect it to SV-2(the second setting value should be higher than SV) then it controls temperature of oven efficiently.

■ Input correction(In-b) function

Input revise is to correct deviation occurred from temperature sensor such as thermocouples, RTD, Analogue sensor etc.

If you check the deviation of every thermo sensor precisely, it can measure temperature accurately.

- Input revise can be set at "First setting group".
- Use this mode after measuring deviation occurred from temperature sensor exactly. Because if measured deviation value is not corrected, displayed temperature may be too high or too low.
- Setting range of input revise is -49 to +50°C(-50.0 to +50.0°C).
- When you set the input revise value, you may need to record it, because it will be useful when performing maintenance.

■ Sub output(Event) function

Sub output can execute as main control output and sub function as well. There is one sub output in this unit.

- This sub output is relay "A" contact output.
- 1 or 2 sub mode can be selected among 7 kinds of alarm mode or LBA operated when the heater line is cut, SBA operated when the sensor line is cut.
- The sub output can be latched on or automatically reset depending on the alarm option mode selected.
- When the sensor line or the heater line is cut, SBA or LBA output turns on. This "output on" status must be reset by turning the power off.
- When using Alarm output it is able to change interval between ON and OFF within range of 1 to 100°C(0.1 to 100.0°C).
- Ex)When alarm set temperature is 200°C, the output turns on when PV increases from 100°C to 200°C. In the case, the output turns on at over 200°C, the output turns off at 198°C.
- [Above Ex] is that it set the interval between ON and OFF as 2°C.]
- Select function of Sub output in second setting group and set value of operation in first setting group.

■ Alarm output

This unit has output for control and sub(Alarm) output by option. (This alarm output is relay output and operates regardless to output for control.)

- Alarm output operates when the temperature of target is getting higher or lower than setting value.
- 1 alarm mode can be selected among 7 kinds of alarm mode at EV1, EV2 in the second setting group.
- Please note below "Operation chart for alarm output" & "Option of alarm output" regard to detailed operation and optional operation.

■ Operation chart for alarm output

AL-0	—	No alarm output
AL-1	<p>OFF SV 100°C ON PV 110°C</p> <p>※When set 10°C in AL 1(AL 2) as deviation temperature.</p>	<p>■Deviation High-limit alarm</p> <p>If deviation between PV and SV is occurring higher than deviation temperature setting value, the output will be ON. The deviation temperature is set in AL 1 or AL 2 of first setting group.</p>
AL-2	<p>ON PV 90°C OFF SV 100°C</p> <p>※When set 10°C in AL 1(AL 2) as deviation temperature.</p>	<p>■Deviation Low-limit alarm</p> <p>If deviation between PV and SV is occurring lower than deviation temperature setting value, the output will be ON. The deviation temperature is set in AL 1 or AL 2 of first setting group.</p>
AL-3	<p>ON PV 90°C OFF SV 100°C ON PV 110°C</p> <p>※When set 10°C in AL 1(AL 2) as deviation temperature.</p>	<p>■Deviation High/Low-limit alarm</p> <p>If deviation between PV and SV is higher or lower than deviation temperature setting value, the output will be ON. The deviation temperature is set in AL 1 or AL 2 of first setting group.</p>
AL-4	<p>OFF PV 90°C ON SV 100°C OFF PV 110°C</p> <p>※When set 10°C in AL 1(AL 2) as deviation temperature.</p>	<p>■Deviation High/Low-limit reverse alarm.</p> <p>If deviation between PV and SV is higher or lower than deviation temperature setting value, the output will be OFF. The deviation temperature is set in AL 1 or AL 2 of first setting group.</p>
AL-5	<p>OFF SV 100°C ON PV 110°C</p> <p>※When set 110°C in AL 1(AL 2) as alarm temperature.</p>	<p>■The absolute value High-limit alarm</p> <p>If PV is equal or higher than alarm temperature setting value, the output will be ON. The deviation temperature is set in AL 1 or AL 2 of first setting group.</p>
AL-6	<p>ON PV 90°C OFF SV 100°C</p> <p>※When set 90°C in AL 1(AL 2) as alarm temperature.</p>	<p>■The absolute value Low-limit alarm</p> <p>If PV is equal or lower than alarm temperature setting value, the output will be ON. The alarm temperature is set in AL 1 or AL 2 of first setting group.</p>

※"b" is interval between ON and OFF the setting range is 1 to 100°C(0.1 to 100.0°C) and can be set at "RHYS" mode in first setting group.

■ Alarm option setting

Symbol	Operation name	Function
RL-A	General alarm	No optional alarm output.
RL-b	Latch function	When alarm output turns on once, the output will be ON continuously.
RL-C	Standby sequency function	It doesn't output at first operation. (When it reaches to first object value)
RL-d	Latch & Standby sequency function	It operates latch & Standby sequence function together.

■ Loop break alarm(LBA)

LBA function is to diagnose an abnormal temperature of the control system. If the temperature of the control system is not changed within ±2°C during setting time of LBA, the LBA output will be ON.

Ex)When setting value(SV) is 300°C, processing value(PV) is 50°C, this unit controls 100%. In this time if there is no change of system temperature it recognizes Heater is cut off then LBA output will be ON.

- LBA output can be selected at EV-1, EV-2 of the second setting group.
- If LBA output is not selected at event output, it will not be displayed.
- Setting range of LBA output is 1 to 999sec.
- If thermal response of the control system is slow, LBA value should be set to a high value.
- LBA output only operates when the manipulated value of the controller is 0% and 100% so, LBA cannot be used when it is Current output.
- In case the LBA output is ON, please check the following :
 - ①Short-circuit or cutting of the temp. sensor.
 - ②Abnormal condition of the equipment(Conductor, sub-relay, etc.)
 - ③Abnormal condition of the load(Heater, cooler)
 - ④Wrong-wiring or cutting of the other cables.
- Once LBA is ON due to broken sensor, it will not output. Although connect sensor again. In this case, turn off the power then turn on again.
- The output of LBA function is EV-1 and EV-2 output.
- If you use LBA function, SBA and alarm operation function cannot be used.

■ Sensor break alarm(SBA)

This function causes the sub output to turn on when the sensor line is cut or open.

It can easily check that the sensor line is cut or not by operating a buzzer using the relay contact.

- Set SBA mode at EV-1 or EV-2 mode in second setting group.
- If intend to use SBA function, LBA and alarm operation function cannot be used.
- The output of SBA function is EV 1 and EV 2 output.

■ Error display

If error is occurred while the controller is operating, it will be displayed as follow.

- "LLLL" is flickering when measured input temperature is lower than input range of the sensor.
- "HHHH" is flickering when measured input temperature is higher than input range of the sensor.
- "oPEn" is flickering when the input sensor is not connected or its wire is cut.

Flow chart for second setting group

If press **MD** & **▲** key for 3sec. at once in RUN state, it will go to second setting group.

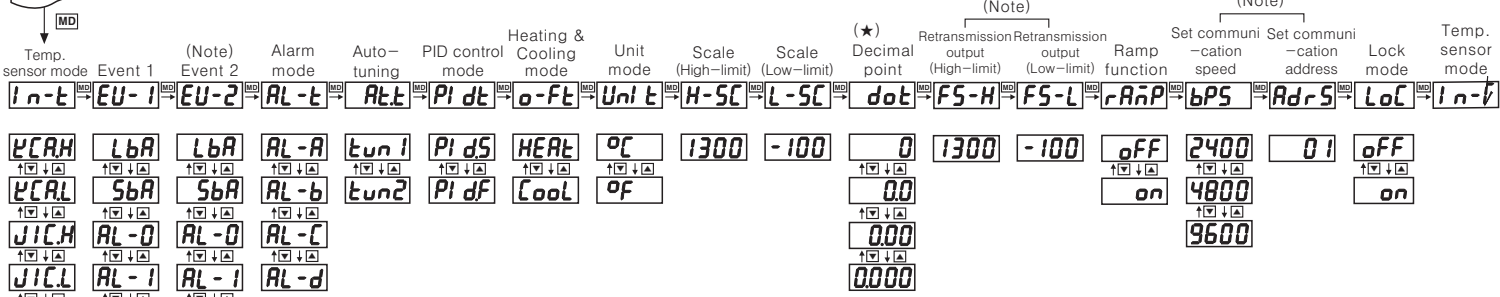

in-t	Input sensor : Select from 19 kinds.	L-SC	Set low-limit scale value(Include analog output)
EU-1	Event 1 : Select from 9 kinds.	dot	Select decimal point position for Analog input.
EU-2	Event 2 : Select from 9 kinds.	FS-H	Set the high-limit scale value when retransmission output is applied. (20mA)
AL-t	Alarm output : Select from 4 kinds.	FS-L	Set the low-limit scale value when retransmission output is applied. (4mA)
AL-t	Auto-tuning : Selectable tun1or tun2.	rAnP	Able to set ON and OFF of Ramp function.
PIdt	PID : Selectable PIDF or PIDS.	bPS	Set communication speed
o-ft	Selectable heat-function or cool-function.	AdrS	Set communication address
Unit	Temperature unit: °C or °F	LoC	The data cannot be changed when the lock key is ON.
H-SC	Set high-limit scale value(Include analog output)		

*It will start to flicker by pressing **◀** key then select each mode by **▲**, **▼** keys.
 After that if press **MD** key, the DATA will be changed then display next mode.
 *The setting will be completed by pressing **MD** key for 3 sec. then it will return to RUN mode.
 *If no key touched for 60sec. in each mode, it will return to RUN mode automatically.
 *"(★)" might not be displayed according to the selection of input Sensor/Voltage/Current S/W.
 *"(Note)" might not be displayed according to the selection of option.

Flow chart for first setting group

If press **MD** key for 3sec. This mode changes to second flow chart.

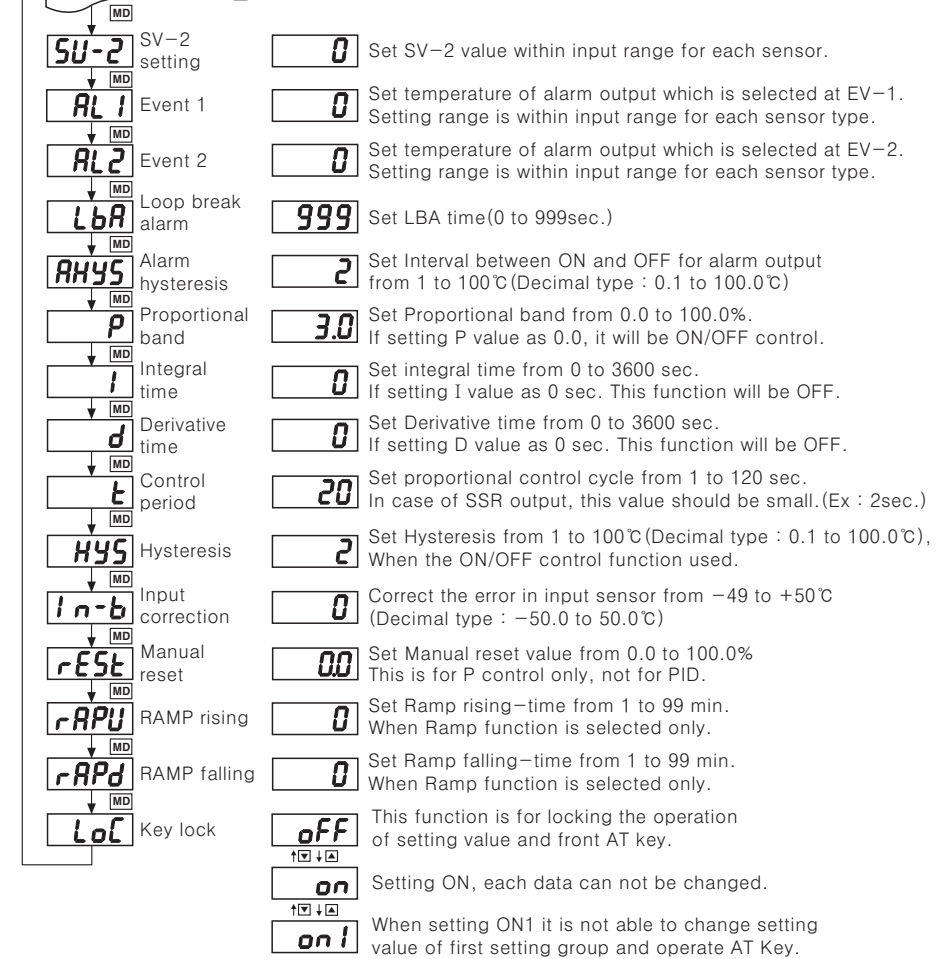

*It will start to flicker by pressing **◀** key and the flicker will be moved by **◀** key then set the value by **▲**, **▼** keys. After that if pressing **MD** key the DATA will be changed then display next mode.
 *It returns to RUN status in case of pressing **MD** key for 3sec. after setting all mode to change.
 *If no key touched for 60sec., it will return to RUN mode automatically.
 *If not to set related mode in second setting group, **AL 1, AL 2, LbA, AHYS, I, d, t, HYS, rAPU, rAPd** mode will disappear.

Connections

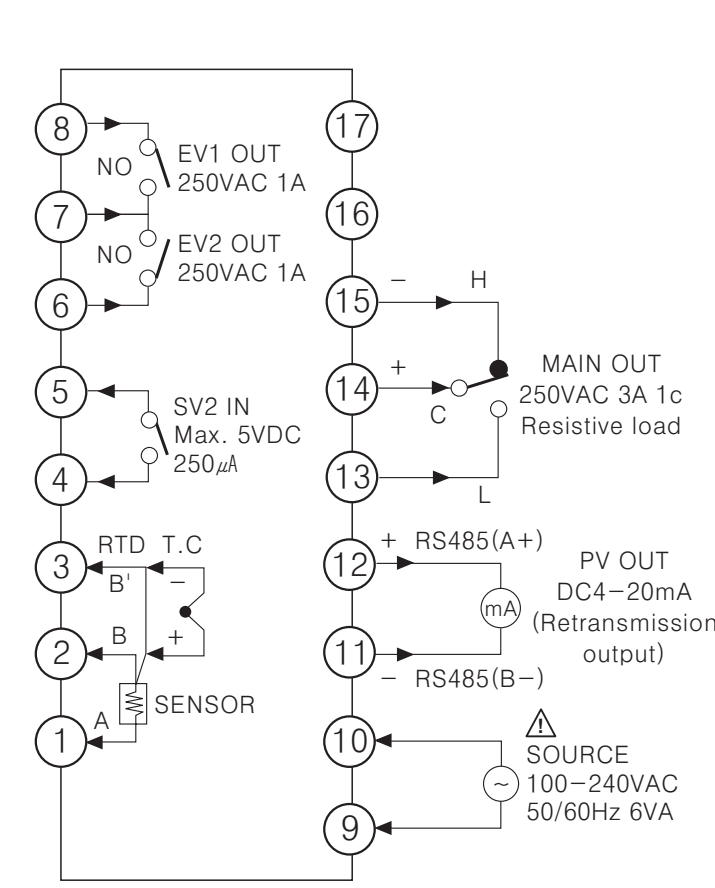

MAIN OUT		
Relay	SSR	Current
250VAC 3A 1c Resistive load	12VDC ±3V 30mA Max.	DC4-20mA Load 600Ω Max.

How to change the set value

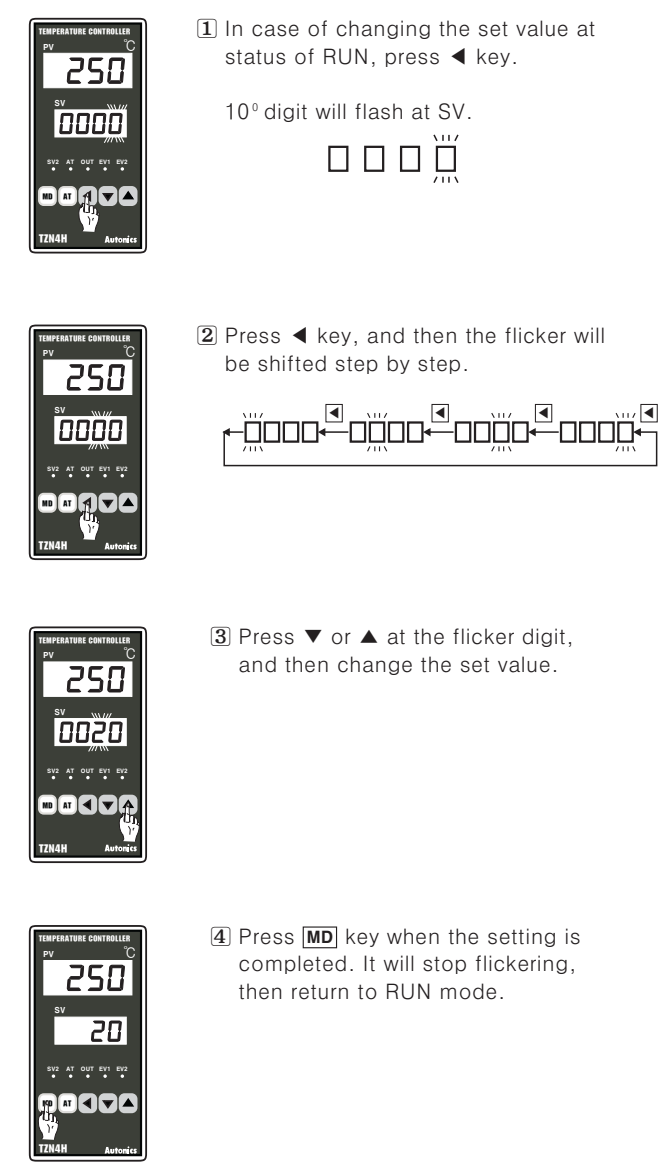

Dimensions

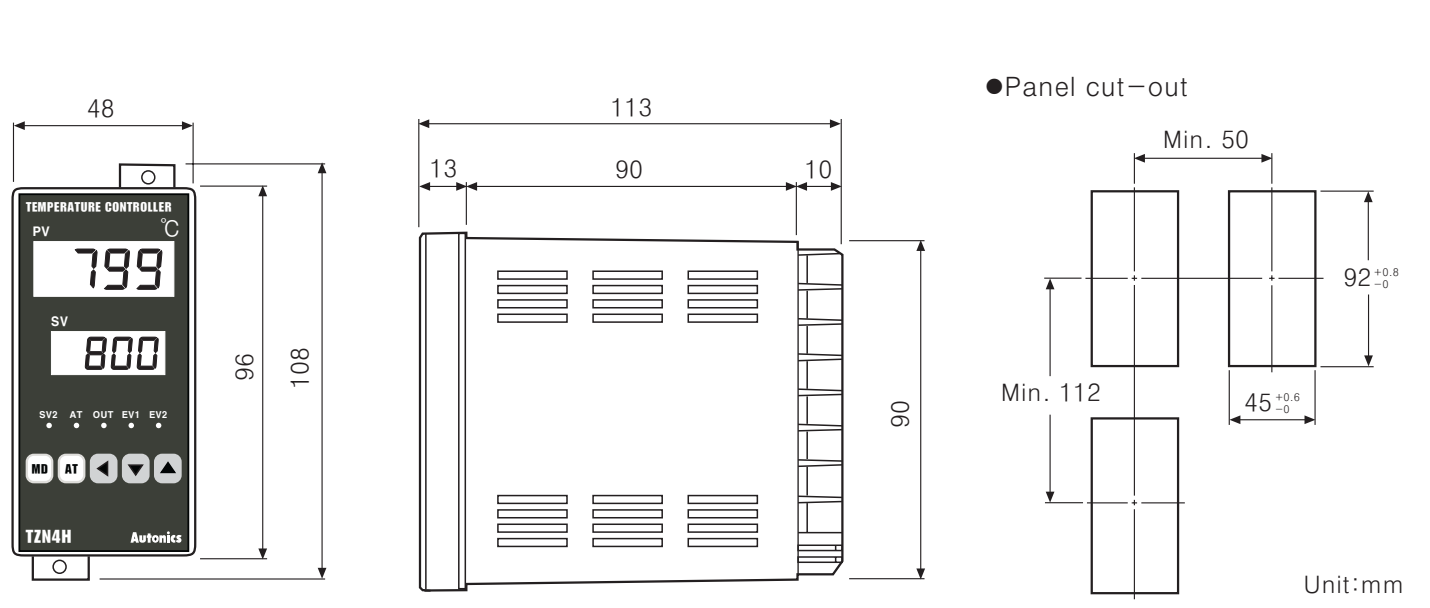

Factory defaults

Second setting group

Mode	Set value	Mode	Set value
ln-t	PCRH	PI dt	PI dS
EU-1	AL-1	o-ft	HEAt
EU-2	AL-2	Unit	°C
AL-t	AL-A	H-SC	1300
Att	tun1	L-SC	-100
rAP	off	LoC	off

First setting group

Mode	Set value	Mode	Set value
SU-2	0	t	20
AL1	10	HYS	2
AL2	10	ln-b	0
LbA	600	rEst	0.0
AHYS	2	rAPU	10
P	3.0	rAPd	10
i	0	LoC	off
d	0		

Applications

Food	Packaging machinery, Banding machinery
Plastic	Plastic machinery, Film making system, etc.
Industry	Electric furnace, Auto soldering machine, Drying machine, etc.
Textile	Body press, Sizing machine

Analog input

In case of measuring or controlling humidity & pressure, flux, etc, it uses the proper converter which is converting the measuring value to 4-20mADC or 1-5VDC or 0-10VDC.

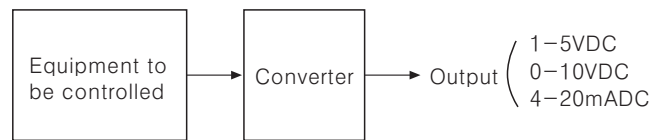

- This unit has the mode for the converter built-in. Please select A--1(0-10VDC) or A--2(1-5VDC) or A--3(4-20mADC) in selection mode of input in second setting group.
- Set the input value by H-SC and L-SC mode.
- The other operation function after doing that is same as controlling the temperature.

Applications

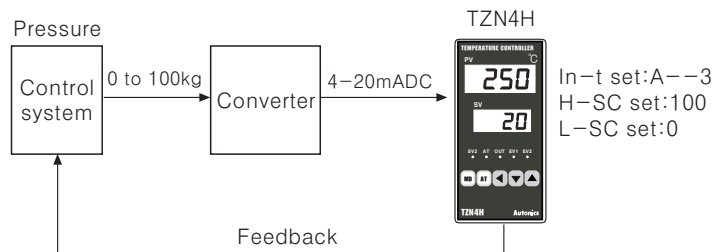

*In case of using the converter mode, please select the inner switching pin according to the chart in "Selection switch for Input sensor/Voltage/Current".

Application of relay output type

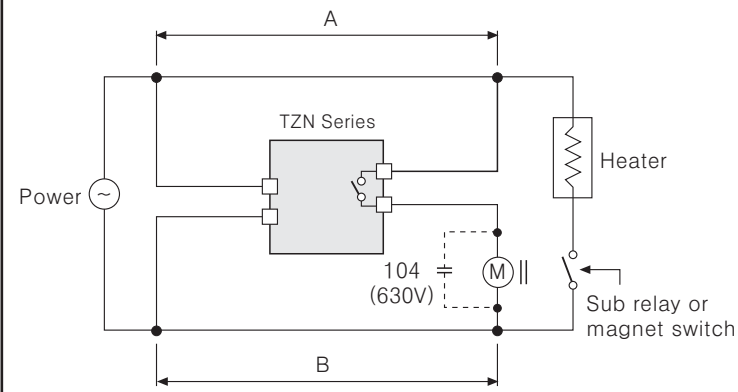

Caution for wiring.

1. Keep power relay as far away as possible from TZ series. If wires length of A or B part is short, electromotive force occurred from a coil of magnet switch & power relay may flow in power line of the unit, it may cause malfunction.
2. If wires length of A or B part is short, please connect a condenser 104(630V) across coil "M" of the power relay to protect electromotive force.

Application of SSR output type

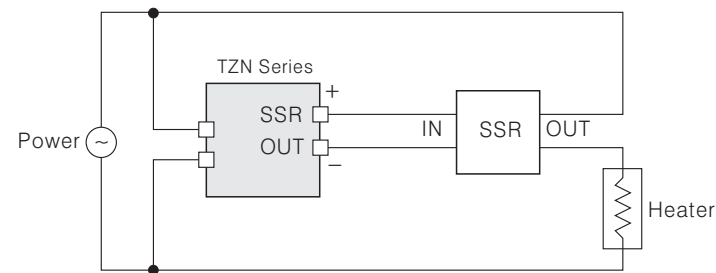

Caution for using SSR

1. SSR should be selected by the capacity of load, otherwise, it may short-circuit and result in a fire.
2. Indirect heated should be used with SSR for efficient working.

Application of current output (4 to 20mADC)

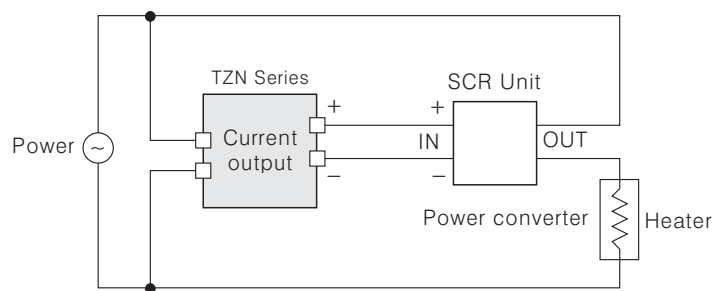

- It is important to select SCR unit after checking the capacity of the load.
- If the capacity is exceeded, it may cause a fire.

Application of Retransmission output (4 to 20mADC)

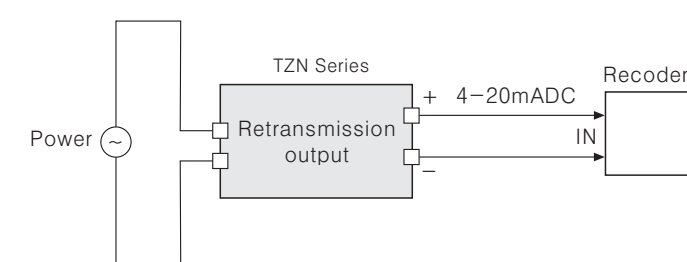

Case detachment



Simple "error" diagnosis

1. When it displays "Open" during operation.

This is a warning that external sensor is cut off. Please turn off power and check the state of sensor. If sensor is not cut off, disconnect sensor line from terminal block and +, - together. When you turn on power it can check room temperature. If this unit cannot indicate room temperature, this unit itself is faulty. Please remove this unit from equipment and service or replace. [When input mode is sensor input mode(thermocouple) only, it can indicate room temperature.]

2. In case of not operating the output(the heater).

Please check operation of the Out lamp located in front panel of the unit. If lamp does not operate, please check the parameter of all programmed mode. If lamp is operating, please check the output(relay, operating voltage for SSR, current output) after separating output line from the unit.

3. In case of indicating "Err0" in display.

This Error message is indicated in case of damaging inner chip program data by outer strong noise. In this case, please send the unit to our after service center after removing the unit from system. Noise protection is designed in this unit, but it does not stand up strong noise continuously. If bigger noise than specified(Max. 2kV) flows in the unit, it can be damaged.

Caution for using

1. Installation environment
 - ① It shall be used indoor
 - ② Altitude Max. 2000m
 - ③ Pollution Degree 2
 - ④ Installation Category II.
2. Please use the terminal(M3.5, Max. 7.2mm) when connect the AC power source.

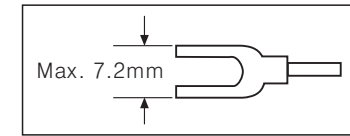

3. Please use separated line from high voltage line or power line in order to avoid inductive noise.
 4. Please install power switch or circuit-breaker in order to cut power supply off.
 5. The switch or circuit-breaker should be installed near by users.
 6. Do not use this product as Volt-meter or Ampere-meter, this is a temperature controller.
 7. Be sure to use compensating wire when extending wire from controller to thermocouple, otherwise a temperature deviation will occur at the point where wires are connected to each other.
 8. In case of using RTD sensor, 3wires type must be used. If you need to extend the line, 3wires must be used with the same resistance as the line. It might cause the deviation of temperature if the resistance of line is different.
 9. In case of making power line and input signal line close, line filter for noise protection should be installed at power line and input signal line should be shielded.
 10. Keep away from the high frequency instruments. (High frequency welding machine & sewing machine, big capacitive SCR controller)
 11. If you want to change the input sensor, reset switches (SW1, SW2) according to each input specification after power off. Turn on power and then set sensor mode by front keys at second flow chart.
 12. In case of changing input sensor, after change it according to SW1, SW2 inside of the unit, select changed sensor with key operation when power on.
 13. Do not connect power line to terminals No. 1, 2, 3, 6, 7, 8(Terminal No. 1, 2, 3 : Sensor connection, Terminal No. 6, 7, 8 : EV-1, EV-2).
- *It may cause malfunction if above instructions are not followed.**

Main products

- COUNTER
- TIMER
- TEMPERATURE CONTROLLER
- PANEL METER
- TACHO/LINE SPEED/PULSE METER
- DISPLAY UNIT
- PROXIMITY SENSOR
- PHOTOELECTRIC SENSOR
- FIBER OPTIC SENSOR
- PRESSURE SENSOR
- ROTARY ENCODER
- SENSOR CONTROLLER
- POWER CONTROLLER
- STEPPING MOTOR & DRIVER & CONTROLLER
- LASER MARKING SYSTEM (CO₂, Nd:YAG)

Autonics Corporation
<http://www.autonics.com>
Satisfiable Partner For Factory Automation
HEADQUARTERS :
 41-5, Yongdang-ri, Ulsang-eup, Yangsan-si, Gyeongnam, 626-847, Korea
INTERNATIONAL SALES :
 Bldg. 402 3rd Fl., Bucheon Techno Park, 193, Yakdae-dong, Wonmi-gu, Bucheon-si, Gyeonggi-do, 420-734, Korea
 TEL: 82-32-329-0722 / FAX: 82-32-329-0728
E-mail : sales@autonics.net