

# Solid State Relays Zero Switching Types RGH Solid State Contactor

CARLO GAVAZZI

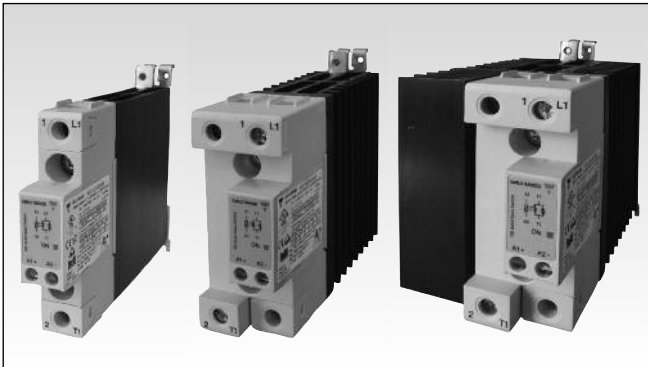

- Product width ranging from 17.5mm to 70mm
- Rated Operational voltage: Up to 600 VAC
- Rated Operational current: Up to 60 AAC @ 40°C
- Up to 6600 A<sup>2</sup>s for I<sup>2</sup>t and 1600Vp blocking voltage
- Control voltages: 4-32 VDC, 20-275 VAC (24-190 VDC)
- IP20 protection
- Design according to EN/IEC60947-4-2, EN/IEC60947-4-3, EN/IEC62314, UL508, CSA22-2 No14-10
- Integrated voltage transient protection with Varistor
- RoHS compliant
- Short circuit current rating: 100kA
- VDE approval

## Product Description

This range of Solid State contactors offers the possibility of 1600Vp blocking voltage as well as the use of a less expensive means for short circuit protection due to the use of semiconductors with high I<sup>2</sup>t ratings combined with a small

width dimension for the product which can go as narrow as 17.5mm for the 20A version. The nominal current ratings are at 40°C.

Specifications are stated at 25°C unless otherwise stated.

## Ordering Key **RGH 1 A 60 A 31 K K E**

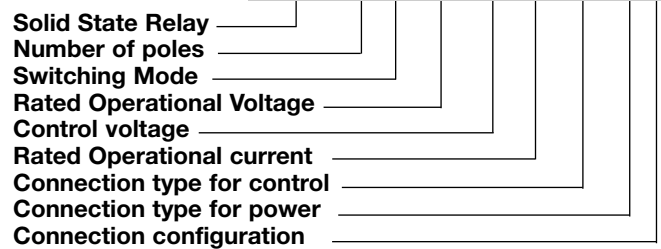

## Ordering Key

1Phase SSR with heatsink	Rated Voltage	Control Voltage	Rated Current	Connection Control	Power	Connection configuration
<b>RGH1A: ZC</b>	60: 600V +10% - 15%, 1600Vp	D: 4-32VDC A: 20-275VAC, 24-190VDC	15: 23AAC, 6600A <sup>2</sup> s 20: 23AAC, 1800A <sup>2</sup> s 21: 23AAC, 6600A <sup>2</sup> s 31: 30AAC, 6600A <sup>2</sup> s 40: 40AAC, 1800A <sup>2</sup> s 41: 40AAC, 6600A <sup>2</sup> s 60: 60AAC, 6600A <sup>2</sup> s	K: Screw M: Pluggable Spring-loaded	K: Screw G: Box Clamp	E: Contactor U: SSR

## Selection Guide (ZC = Zero Cross Switching)

Rated Output Voltage	Blocking Voltage	Connection Control/ Power	Control Voltage	Connection Type	Rated Operational Current @ 40°C (I <sup>2</sup> t value in brackets)			
					23 AAC (6600 A <sup>2</sup> s)	23 AAC (1800 A <sup>2</sup> s)	23 AAC (6600 A <sup>2</sup> s)	30 AAC (6600 A <sup>2</sup> s)
600VAC, ZC	1600Vp	Screw/ Screw	4-32VDC	E-type	RGH1A60D15KKE	RGH1A60D20KKE	RGH1A60D21KKE	RGH1A60D31KKE
		Spring/ Screw	4-32VDC	E-type	RGH1A60D15MKE	RGH1A60D20MKE	RGH1A60D21MKE	RGH1A60D31MKE
		Screw/ Screw	20-275VAC, 24-190VDC	E-type	RGH1A60A15KKE	RGH1A60A20KKE	RGH1A60A21KKE	RGH1A60A31KKE
		Spring/ Screw	20-275VAC, 24-190VDC	E-type	RGH1A60A15MKE	RGH1A60A20MKE	RGH1A60A21MKE	RGH1A60A31MKE

Rated Output Voltage	Blocking Voltage	Connection Control/ Power	Control Voltage	Connection Type	Rated Operational Current @ 40°C (I <sup>2</sup> t value in brackets)		
					40 AAC (1800 A <sup>2</sup> s)	40 AAC (6600 A <sup>2</sup> s)	60 AAC (6600 A <sup>2</sup> s)
600VAC, ZC	1600Vp	Screw/ Box clamp	4-32VDC	E-type	RGH1A60D40KGE	RGH1A60D41KGE	RGH1A60D60KGE
		Screw/ Box clamp	4-32VDC	U-type	-	RGH1A60D41KGU	RGH1A60D60KGU
		Spring/ Box clamp	4-32VDC	E-type	-	RGH1A60D41MGE	-
		Screw/ Box clamp	20-275VAC, 24-190VDC	E-type	RGH1A60A40KGE	RGH1A60A41KGE	RGH1A60A60KGE
		Screw/ Box clamp	20-275VAC, 24-190VDC	U-type	-	RGH1A60A41KGU	RGH1A60A60KGU
		Spring/ Box clamp	20-275VAC, 24-190VDC	E-type	-	RGH1A60A41MGE	-

## Output Voltage Specifications

Operational voltage range	42-600 VAC, +10% -15% on maximum
Blocking voltage	1600 Vp
Internal varistor	680 V

## Environmental Specifications

Operating Temperature	-40°C to 80°C (-40°F to +176°F)
Storage Temperature	-40°C to 100°C (-40°F to +212°F)
RoHS (2002/95/EC)	Compliant
Impact resistance (EN 50155, EN 61373)	15/11 g/ms
Vibration resistance (2-100Hz, IEC60068-2-26, EN50155, EN61373)	2g per axis
Relative humidity	95% non-condensing @ 40°C
UL flammability rating (housing)	UL 94 V0

## General Specifications

Latching voltage (across L1-T1)	≤20V	Pollution degree	2 (non-conductive pollution with possibilities of condensation)
Operational frequency range	45 to 65Hz	Over-voltage category	III (fixed installations)
Power factor	> 0.5 @ Vrated	Isolation	
Touch Protection	IP20	Input to Output	4000Vrms
Control input status	continuously ON Green LED, when control input is applied	Input&Output to Case	4000Vrms

## Input specifications

	RGH..D.. <sup>1</sup>	RGH..A..
Control voltage range	4 - 32 VDC	20 - 275 VAC, 24 (-10%) - 190VDC
Pick-up voltage	3.8 VDC	20VAC/DC
Drop-out voltage	1 VDC	5VAC/DC
Maximum Reverse voltage	32 VDC	-
Response time pick-up	0.5 cycle + 500µs @ 24VDC	2 cycles @ 230VAC/110VDC
Response time drop-out	0.5 cycle + 500µs @ 24VDC	0.5 cycle + 40ms @ 230VAC/ 110VDC
Input current @ 40°C	See diagrams below	See diagrams below

### RG..D..

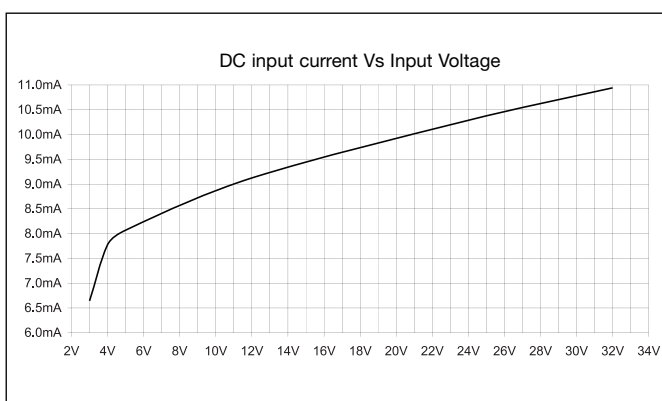

1: DC control to be supplied by a Class 2 power source

### RG..A..

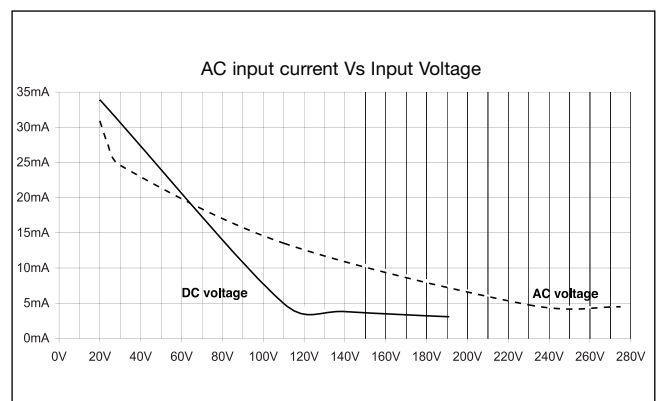

## Motor Ratings: HP (UL508) / kW (EN/IEC60947-4-2) @ 40°C

	115 VAC	230 VAC	400 VAC	480 VAC	600 VAC
RGH..15	1/3HP / 0.18kW	1HP / 0.37kW	2HP / 0.75kW	3HP / 1.1kW	3HP / 1.5kW
RGH..20/21	1/2HP / 0.18kW	1-1/2HP / 0.37kW	2HP / 0.75kW	3HP / 1.1kW	3HP / 1.5kW
RGH..31	3/4HP / 0.37kW	2HP / 1.1kW	3HP / 1.5kW	5HP / 2.2kW	5HP / 3.7kW
RGH..40	3/4HP / 0.37kW	2HP / 1.1kW	3HP / 1.5kW	5HP / 2.2kW	5HP / 3.7kW
RGH..41	1 1/2HP / 0.56kW	3HP / 1.5kW	5HP / 2.2kW	7 1/2HP / 3.7kW	10HP / 4kW
RGH..60	2HP / 0.75kW	3HP / 1.5kW	5HP / 4kW	7 1/2HP / 4kW	10HP / 5.5kW

## Output Specifications (@ 25°C unless otherwise specified)

	RGH..15	RGH..20	RGH..21	RGH..31	RGH..40	RGH..41	RGH..60
Rated operational current	23 AAC	25.5 AAC	25.5 AAC	30 AAC	43.7 AAC	49 AAC	75 AAC
AC-51 rating @ Ta=25°C	23 AAC	23 AAC	23 AAC	30 AAC	40 AAC	40 AAC	60 AAC
AC-51 rating @ Ta=40°C	5 AAC	5 AAC	5 AAC	10 AAC	10 AAC	13 AAC	18 AAC
AC-53a rating @ Ta=40°C							
Number of motor starts (x:6, Tx:6s, F:50%) at 40°C <sup>2</sup>	30	30	30	30	30	30	30
Min. operational current	400 mAAC	250 mAAC	400 mAAC	400 mAAC	250 mAAC	400 mAAC	400 mAAC
Rep. overload current - (Motor Rating) PF = 0.4 - 0.5 UL508: T <sub>AMB</sub> =40°C, t <sub>ON</sub> =1s, t <sub>OFF</sub> =9s, 50cycles	60 AAC	60 AAC	60 AAC	84 AAC	84 AAC	126 AAC	144 AAC
Maximum transient surge current (I <sub>TSM</sub> ), t=10ms	1150 Ap	600 Ap	1150 Ap	1150 Ap	600 Ap	1150 Ap	1150 Ap
Maximum off-state leakage current at rated voltage	3 mA	3 mA	3 mA	3 mA	3 mA	3 mA	3 mA
I <sup>2</sup> t for fusing (t=10ms) Min.	6600 A <sup>2</sup> s	1800 A <sup>2</sup> s	6600A <sup>2</sup> s	6600A <sup>2</sup> s	1800A <sup>2</sup> s	6600A <sup>2</sup> s	6600A <sup>2</sup> s
Critical dv/dt (@ T <sub>j</sub> init = 40°C)	1000 V/us	1000 V/us	1000 V/us	1000 V/us	1000 V/us	1000 V/us	1000 V/us

<sup>2</sup> Overload current profile definition:  
x: multiple of AC53a rating, Tx: duration of current surge, F: duty cycle

## Output Power Dissipation

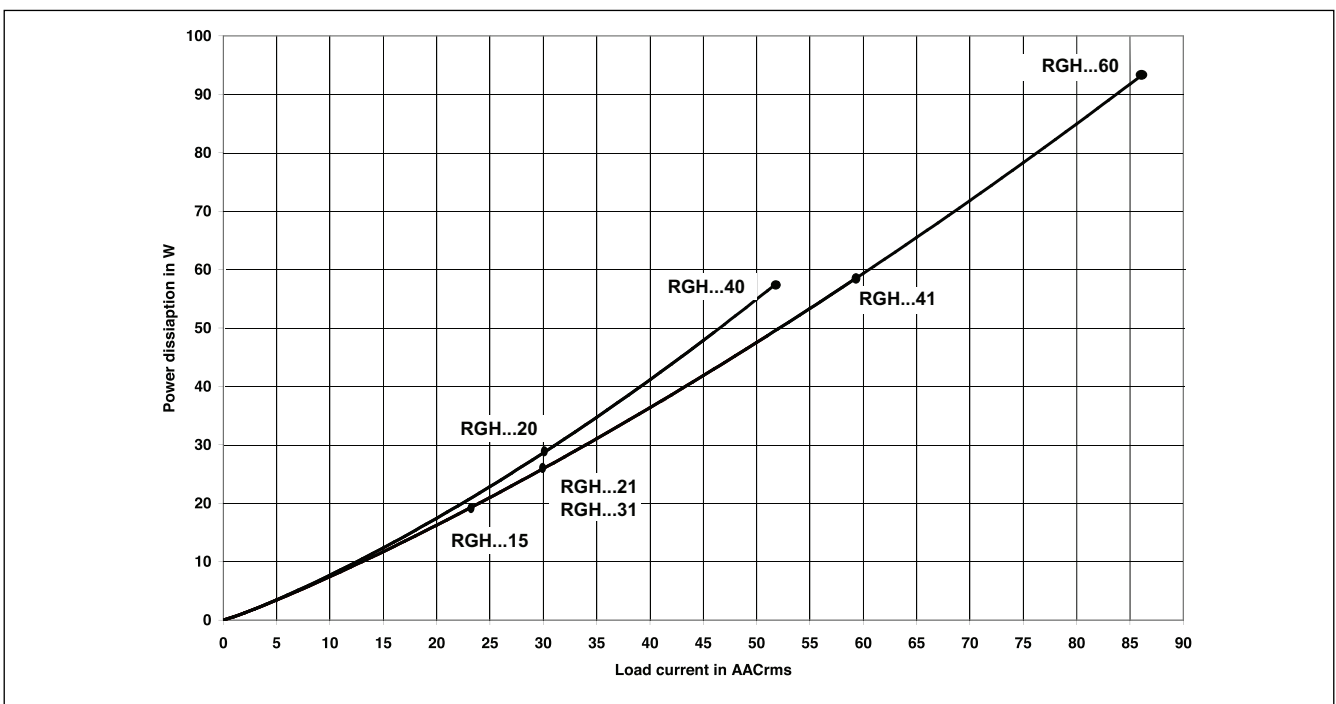

## Agency Approvals and Conformances

Conformance	IEC/EN 62314	Agency Approvals	UL508 Listed (E172877)
	IEC/EN 60947-4-2		cUL Listed (E172877)
	IEC/EN 60947-4-3	Short Circuit Current rating	100kA, UL508



## Electromagnetic Compatibility

<b>EMC Immunity</b>	IEC/EN 61000-6-2	<b>Radiated Radio Frequency Immunity</b>	IEC/EN 61000-4-3
<b>Electrostatic Discharge (ESD) Immunity</b>	IEC/EN 61000-4-2	10V/m, 80 - 1000 MHz	Performance Criteria 1
Air discharge, 8kV	Performance Criteria 1	10V/m, 1.4 - 2.0GHz	Performance Criteria 1
Contact, 4kV	Performance Criteria 1	3V/m, 2.0 - 2.7GHz	Performance Criteria 1
<b>Electrical Fast Transient (Burst) Immunity</b>	IEC/EN 61000-4-4	<b>Conducted Radio Frequency Immunity</b>	IEC/EN 61000-4-6
Output: 2kV, 5kHz	Performance Criteria 1	10V/m, 0.15 - 80 MHz	Performance Criteria 1
Input: 1kV, 5kHz	Performance Criteria 1	<b>Voltage Dips Immunity</b>	IEC/EN 61000-4-11
<b>Electrical Surge Immunity</b>	IEC/EN 61000-4-5	0% for 10ms/20ms,	Performance Criteria 2
Output, line to line, 1kV	Performance Criteria 1	40% for 200ms	Performance Criteria 2
Output, line to earth, 2kV	Performance Criteria 1	70% for 500ms	Performance Criteria 2
Input, line to line, 1kV	Performance Criteria 2	<b>Voltage Interruptions Immunity</b>	IEC/EN 61000-4-11
Input, line to earth, 2kV	Performance Criteria 2	0% for 5000ms	Performance Criteria 2
<b>EMC Emission</b>	EN/IEC 61000-6-4	<b>Radio Interference</b>	
<b>Radio Interference</b>		<b>Field Emission (Radiated)</b>	IEC/EN 55011
<b>Voltage Emission (Conducted)</b>	IEC/EN 55011	<b>30 - 1000MHz</b>	Class A (industrial)
0.15 - 30MHz	Class A (industrial) with filters - see filter information		
	IEC/EN 60947-4-2, 60947-4-3		
	Class A (no filtering needed)		

## Filtering - EN / IEC 55011 Class A compliance (for class B compliance contact us)

Part Number	Suggested filter for compliance	Maximum Heater current
RGH1A60..15	220 nF / 760 V / X1	20A
RGH1A60..20	150 nF / 760 V / X1	20A
RGH1A60..21	220 nF / 760 V / X1	20A
RGH1A60..31	220 nF / 760 V / X1	30A
RGH1A60..40/41	330 nF / 760 V / X1	40A
RGH1A60..60	330 nF / 760 V / X1 470 nF / 760 V / X1	40A 65A

Note:

- Control input lines must be installed together to maintain products' susceptibility to Radio Frequency interference.
- Use of AC solid state relays may, according to the application and the load current, cause conducted radio interferences. Use of mains filters may be necessary for cases where the user must meet E.M.C requirements. The capacitor values given inside the filtering specification tables should be taken only as indications, the filter attenuation will depend on the final application.
- Performance Criteria 1: No degradation of performance or loss of function is allowed when the product is operated as intended.
- Performance Criteria 2: During the test, degradation of performance or partial loss of function is allowed. However when the test is complete the product should return operating as intended by itself.
- Performance Criteria 3: Temporary loss of function is allowed, provided the function can be restored by manual operation of the controls.

## Filter Connection Diagrams

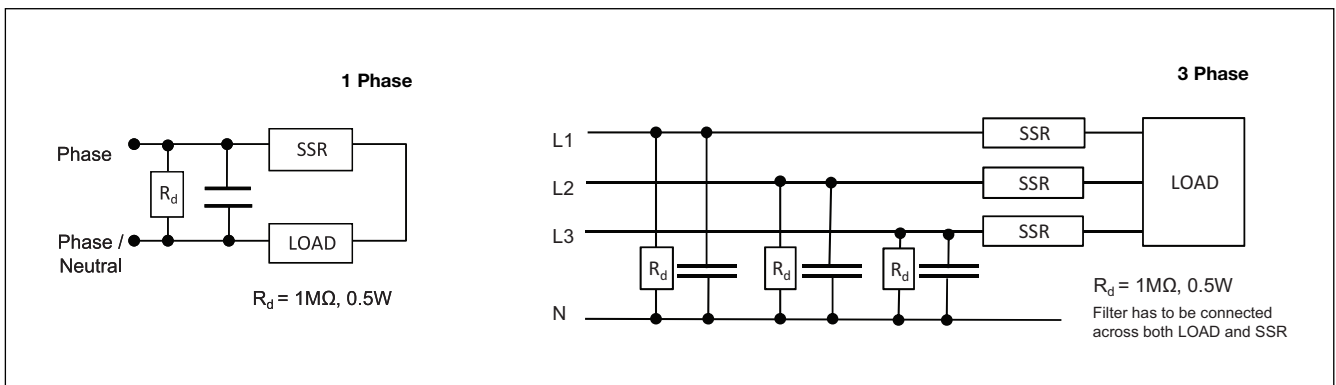

## Current Derating

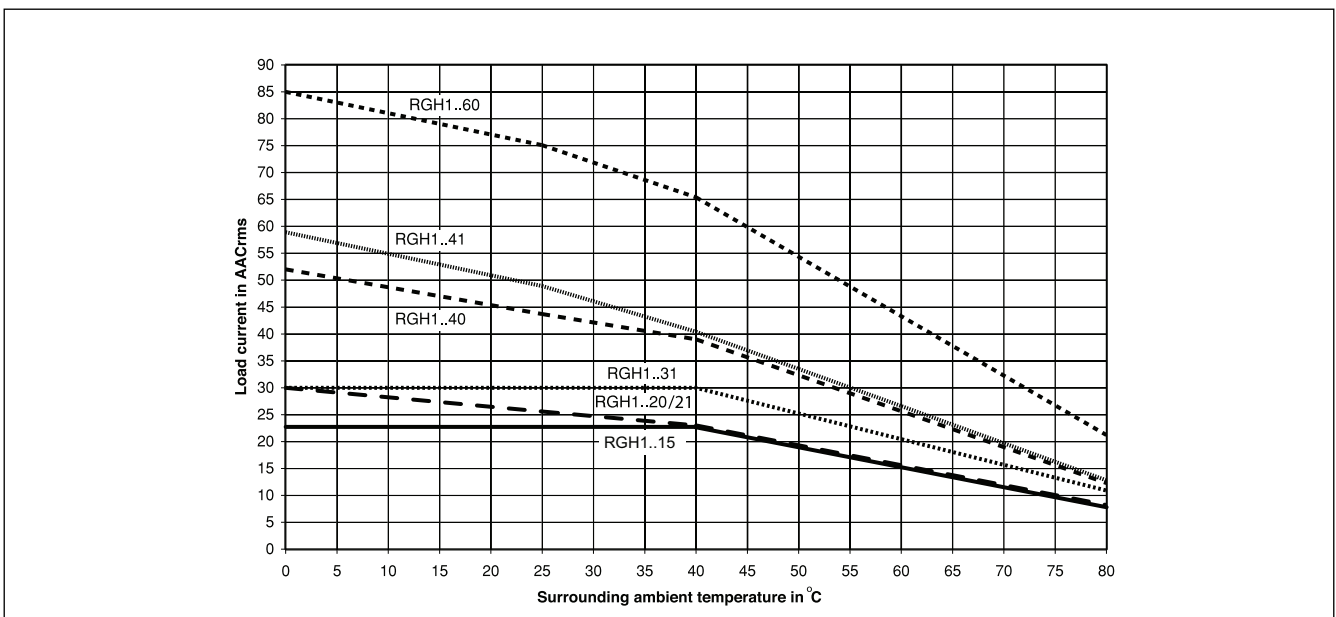

## Derating vs. Spacing Curves

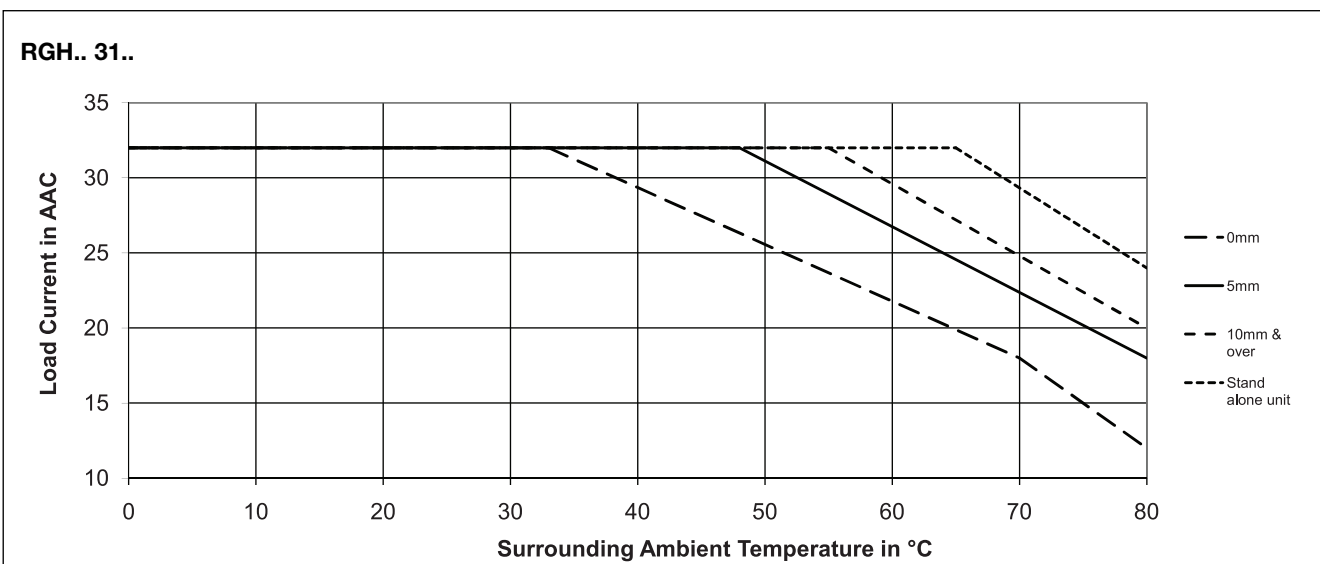
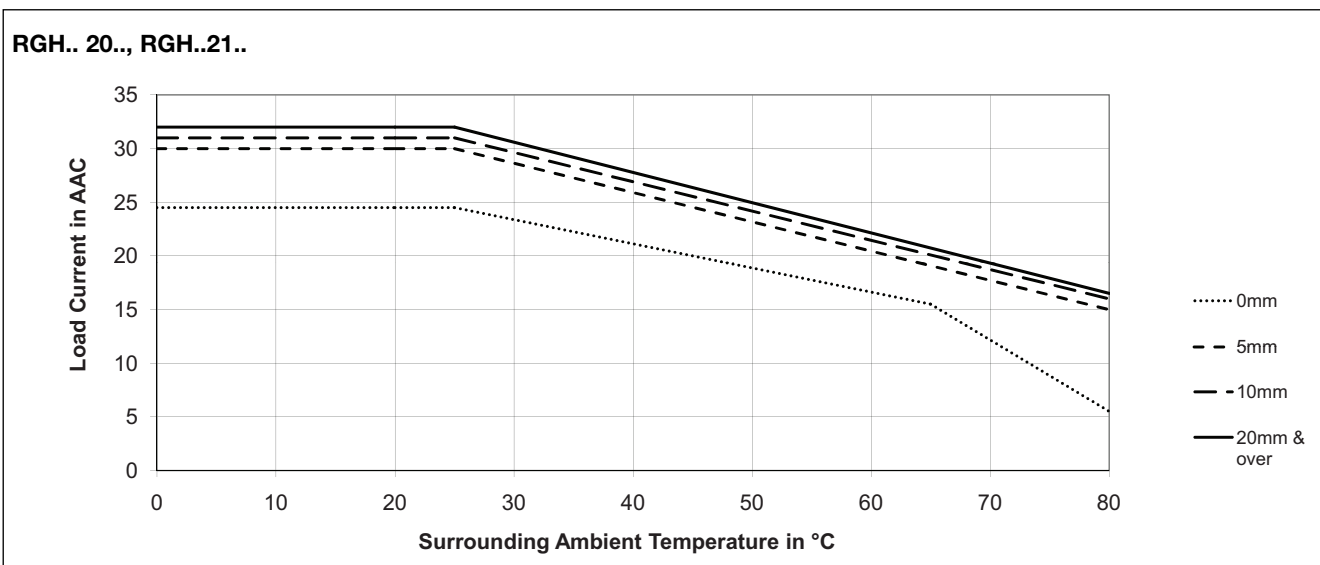
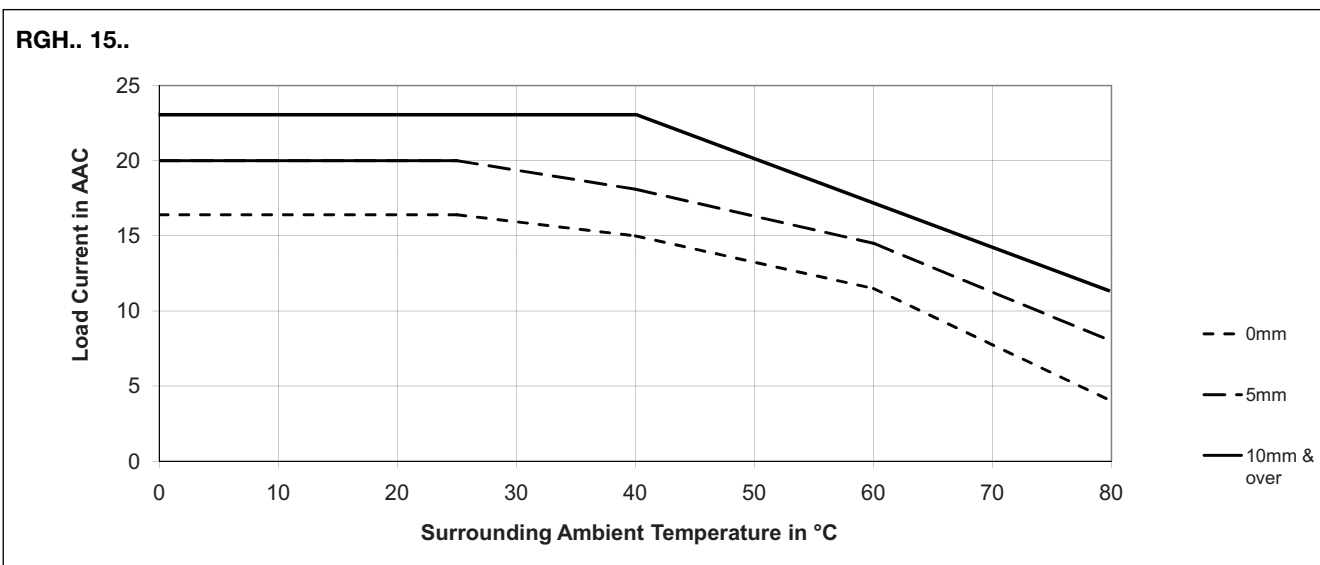

## Derating vs. Spacing Curves (cont.)

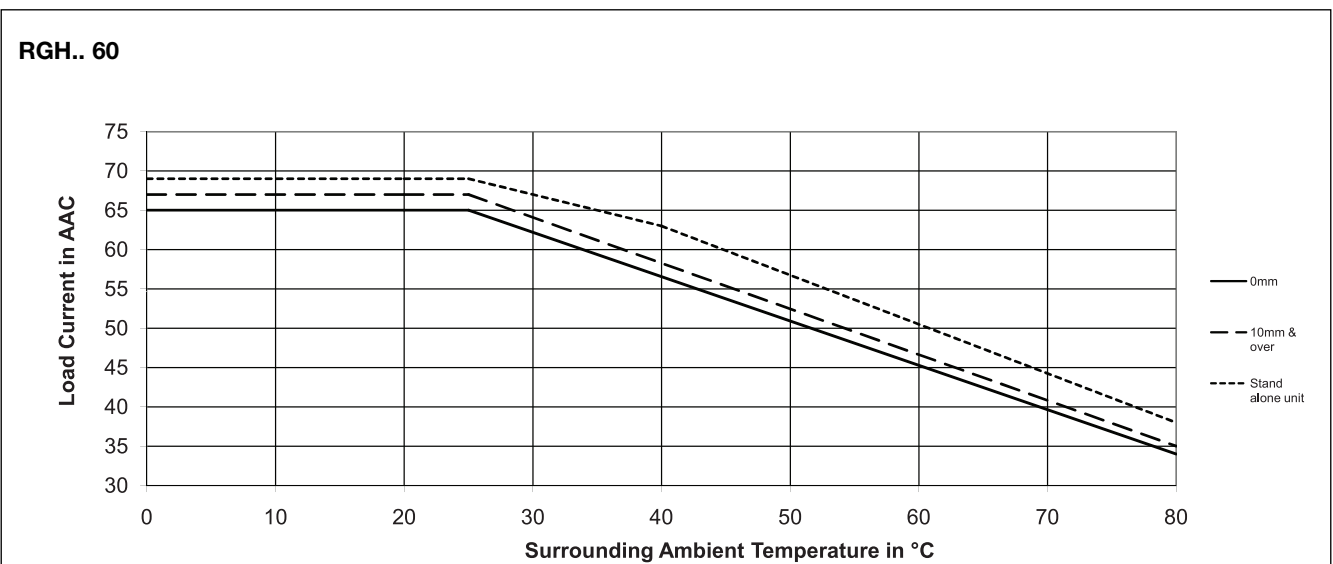
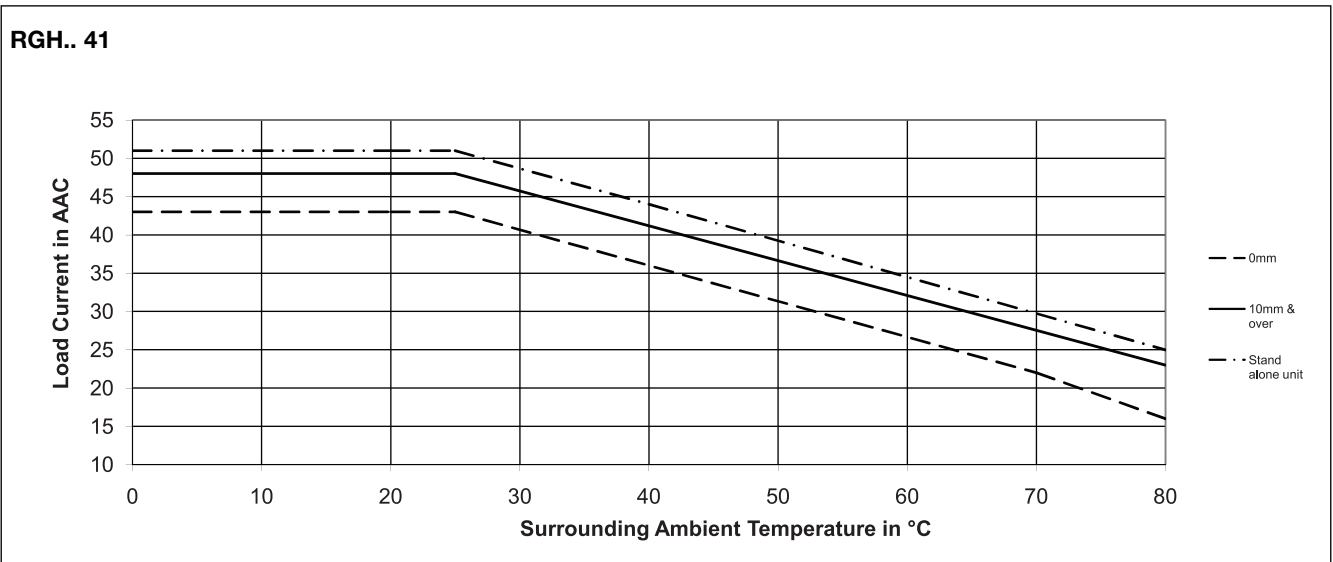
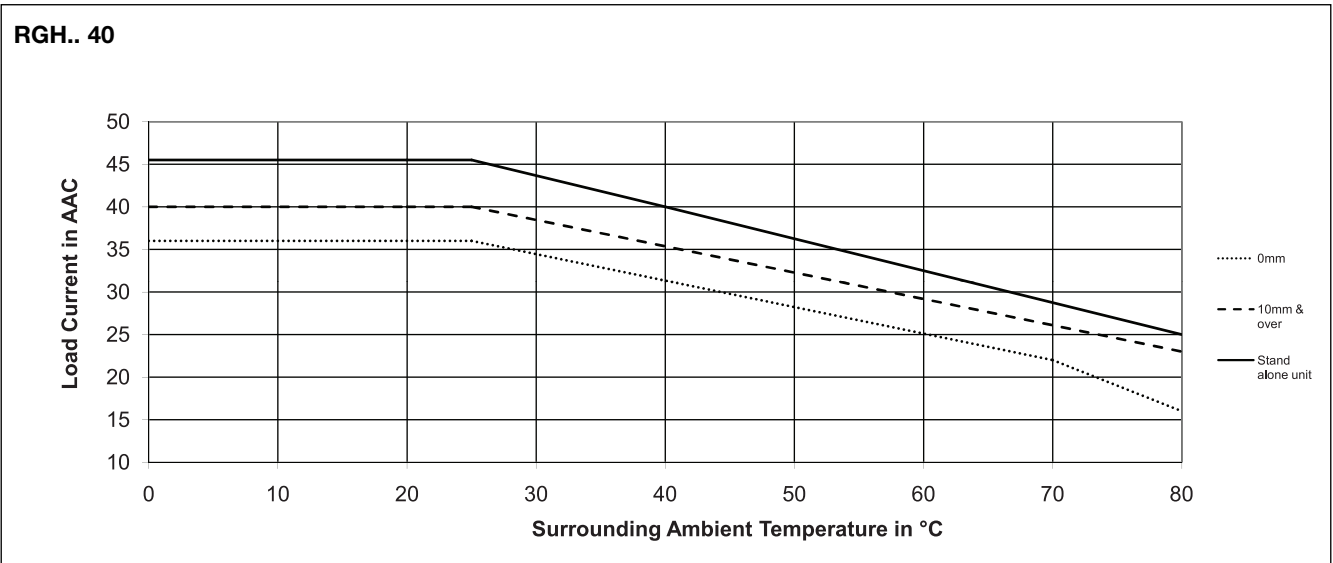

## Terminal Layout and Dimensions

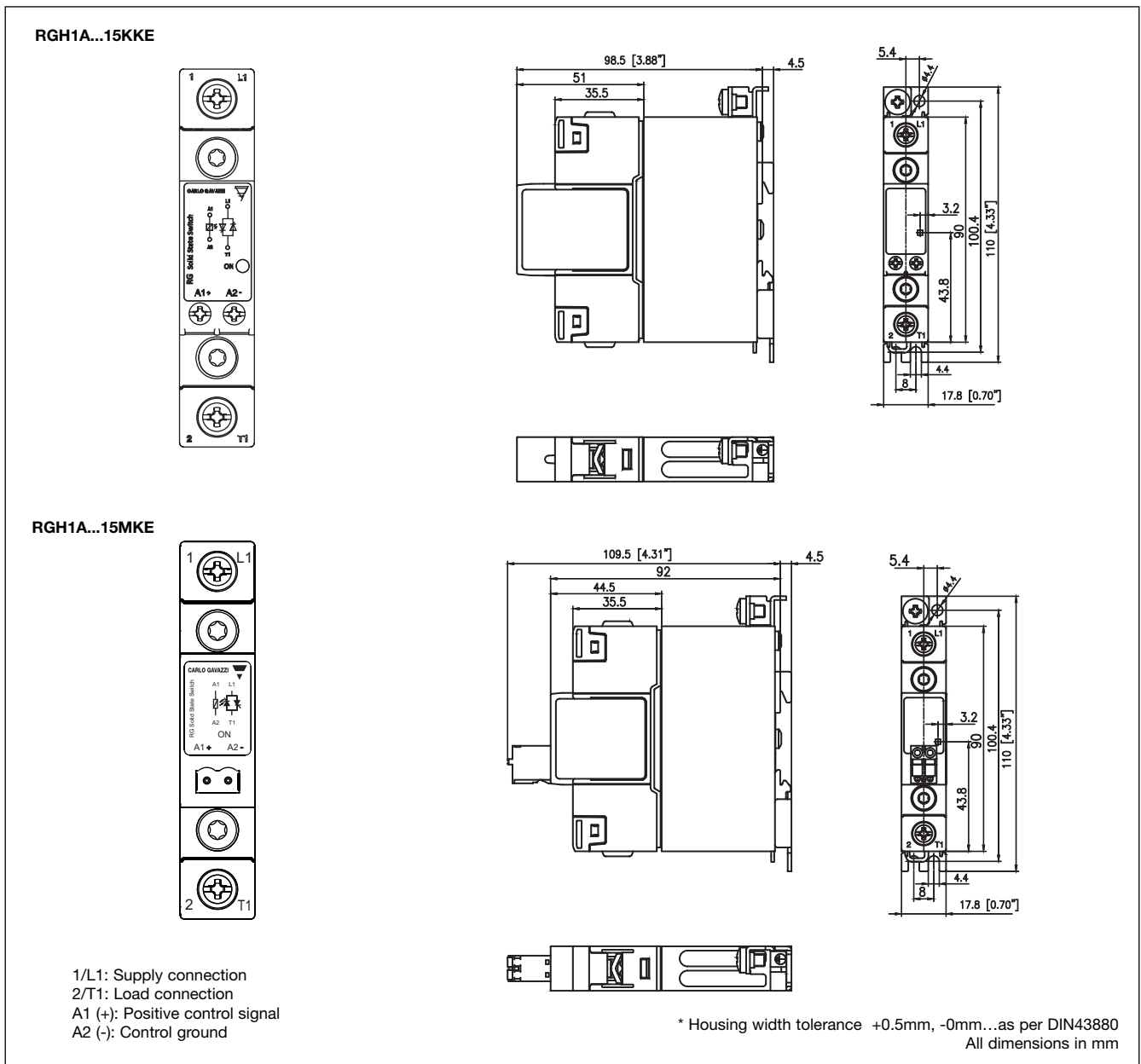



## Terminal Layout and Dimensions (cont.)

RGH1A...20KKE, RGH1A...21KKE

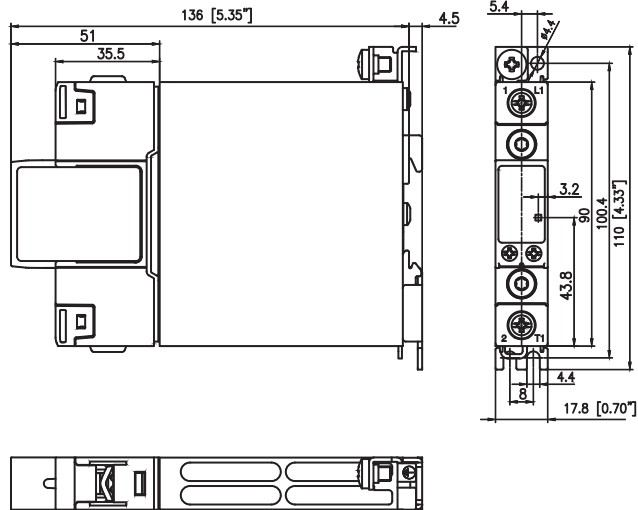
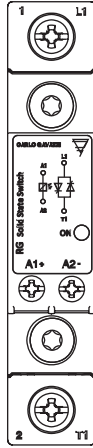

RGH1A...20MKE, RGH1A...21MKE

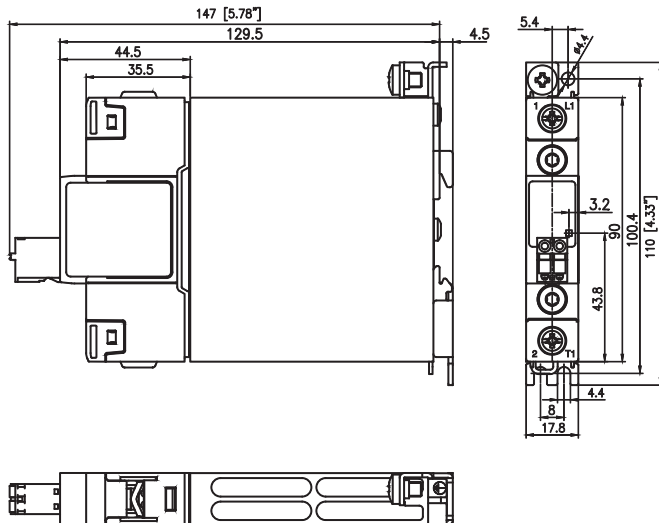
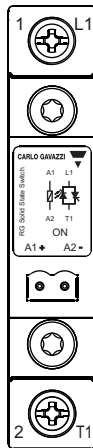

RGH1A...31KKE

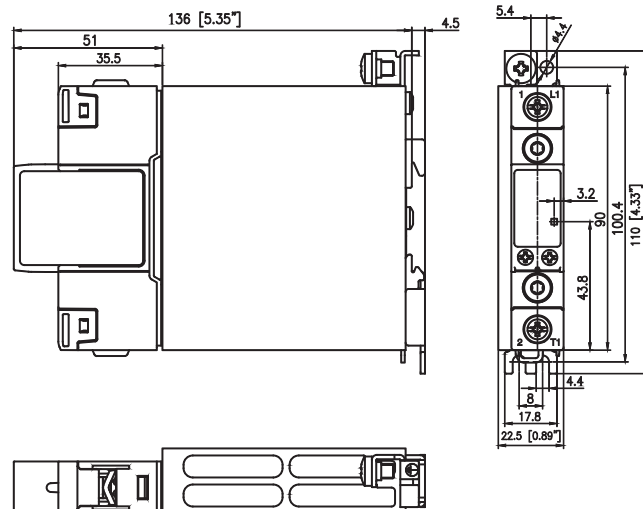
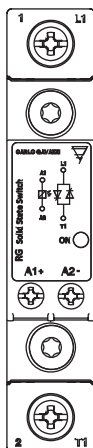

- 1/L1: Supply connection
- 2/T1: Load connection
- A1(+): Positive control signal
- A2(-): Control ground
- ⊕ : Protective earth

\* Housing width tolerance +0.5mm, -0mm...as per DIN43880  
All dimensions in mm

## Terminal Layout and Dimensions (cont.)

RGH1A...31MKE

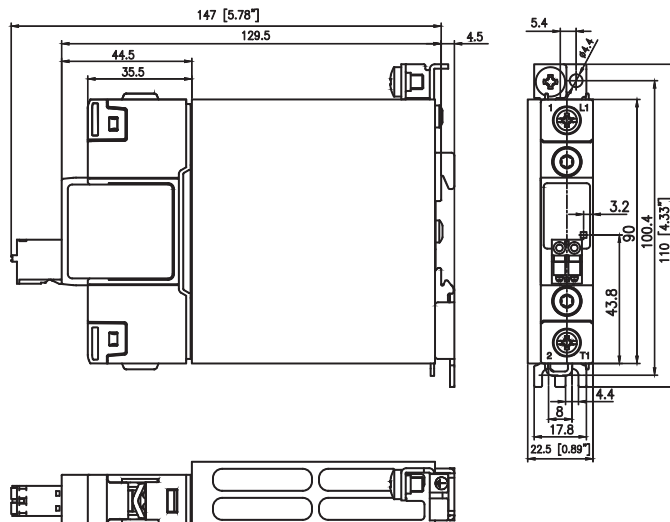
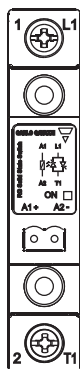

RGH1A...40KGE, RGH1A...41KGE

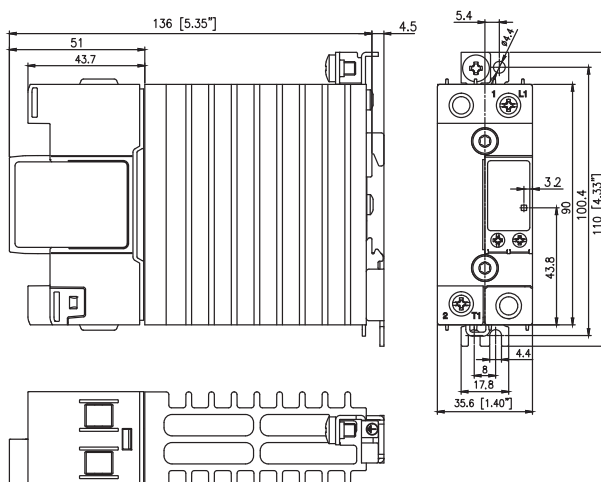
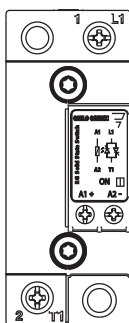

RGH1A...41MGE

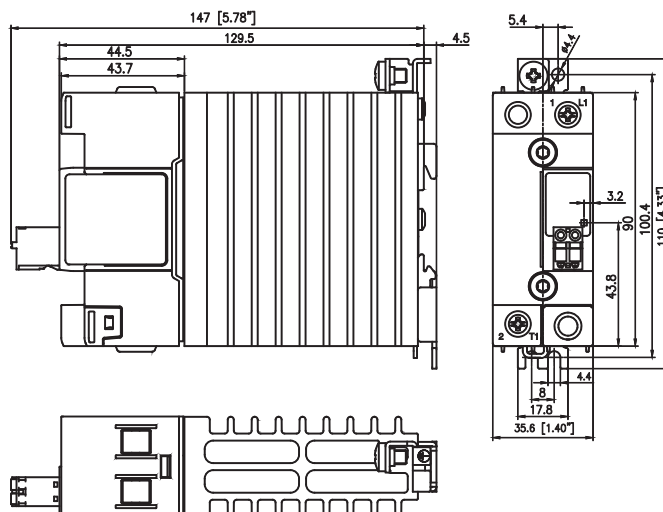
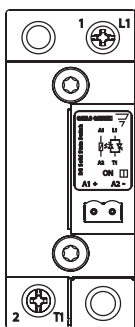

- 1/L1: Supply connection
- 2/T1: Load connection
- A1(+): Positive control signal
- A2(-): Control ground
- ⊕ : Protective earth

\* Housing width tolerance +0.5mm, -0mm...as per DIN43880  
All dimensions in mm

## Terminal Layout and Dimensions (cont.)

RGH1A...41KGU

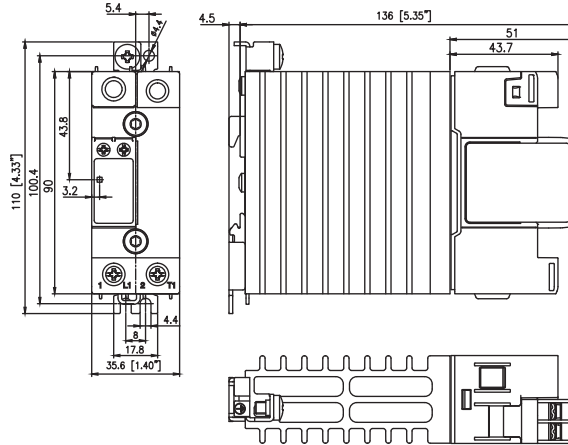
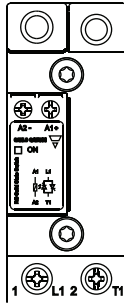

RGH1A...60KGE

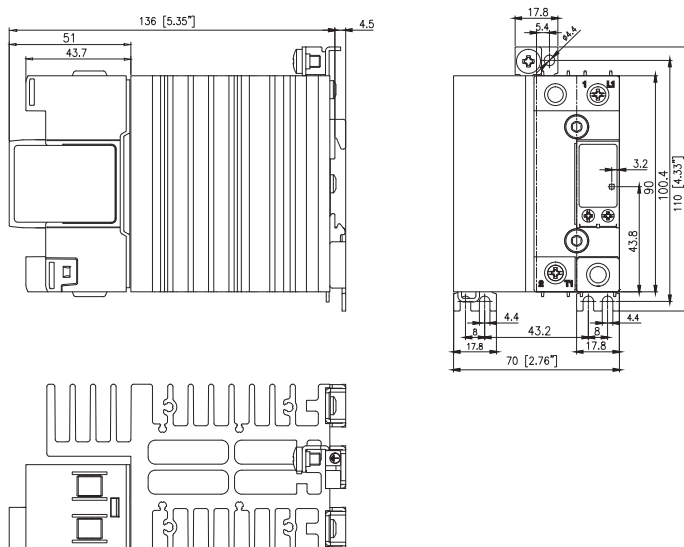
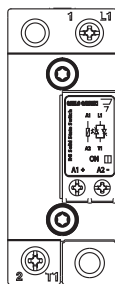

RGH1A...60KGU

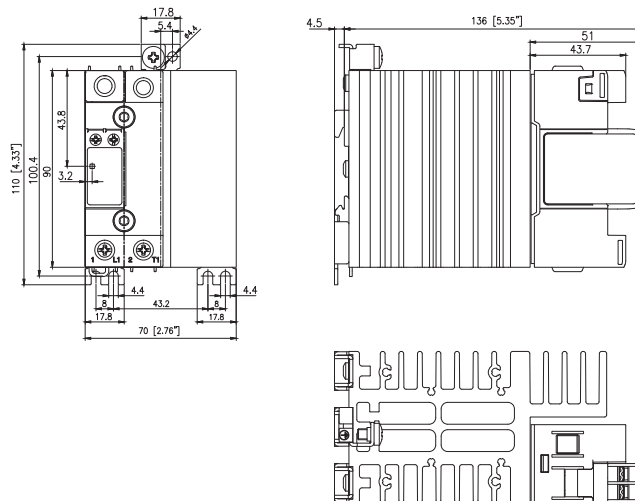
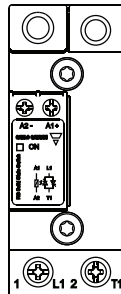

- 1/L1: Supply connection
- 2/T1: Load connection
- A1(+): Positive control signal
- A2(-): Control ground
- ⊕ : Protective earth

\* Housing width tolerance +0.5mm, -0mm...as per DIN43880  
All dimensions in mm

## Connection Diagram

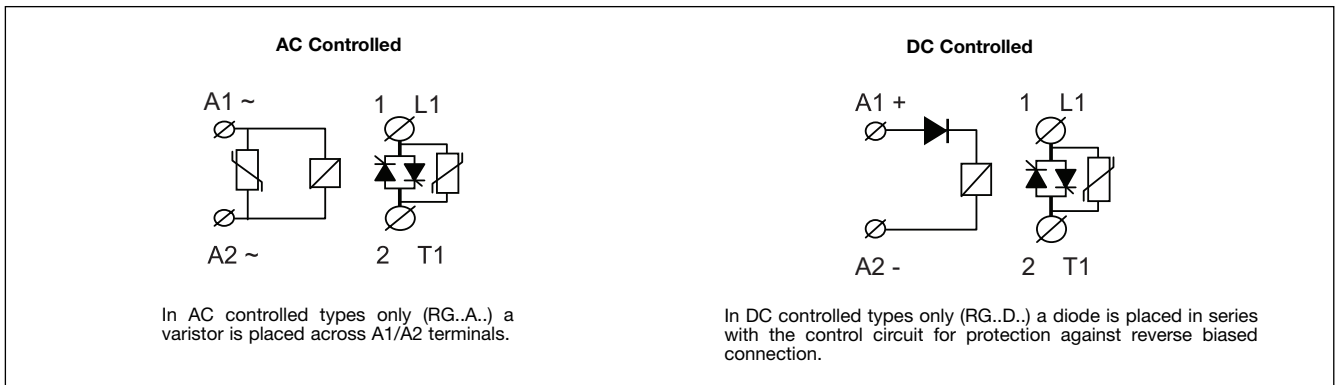

## Connection Specifications

**POWER CONNECTIONS: 1/L1, 2 /T1**

Use 75°C copper (Cu) conductors

	RGH..15; RGH..20/21; RGH..31	RGH..40/41; RGH..60
<b>Stripping Length (X)</b>	12mm	11mm
<b>Connection type</b>	M4 screw with captivated washer	M5 screw with box clamp
<b>Rigid (Solid &amp; Stranded)</b> UL/ cUL rated data	 2 x 2.5..6 mm <sup>2</sup> 2 x 14.. 10 AWG	 1 x 2.5..6 mm <sup>2</sup> 1 x 14.. 10 AWG 1 x 6..25mm <sup>2</sup> 1 x 10.. 3 AWG
<b>Flexible with end sleeve</b>	 2 x 1.0...2.5mm <sup>2</sup> 2 x 2.5...4mm <sup>2</sup> 2 x 18...14AWG 2 x 14...12 AWG	 1 x 1.0..4mm <sup>2</sup> 1 x 18.. 12 AWG 1 x 2.5..16mm <sup>2</sup> 1 x 14.. 6 AWG
<b>Flexible without end sleeve</b>	 2 x 1.0...2.5mm <sup>2</sup> 2 x 2.5...6mm <sup>2</sup> 2 x 18...14AWG 2 x 14...10 AWG	 1 x 1.0..6mm <sup>2</sup> 1 x 18.. 10 AWG 1 x 4..25mm <sup>2</sup> 1 x 12.. 3 AWG
<b>Torque specifications</b>	2 Nm (17.7 in-lb). M4, Pozidriv 2	2.5 Nm (22 in-lb). M5, Pozidriv 2
<b>Aperture for termination lug</b>	12.3mm	-
<b>Protective Earth Connection</b>	 M5, 1.5Nm (13.3 in-lb)	

**CONTROL CONNECTIONS: A1(+), A2(-) for RGH...KKE, KGU, KGE**

**Torque specifications**



0.5 Nm (4.4 in-lb)  
 M3, Pozidriv 1  
 Use 60/75°C copper (Cu) conductors  
 8mm

**Stripping Length (X)**

**Rigid (Solid & Stranded)**

UL/ cUL rated data

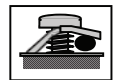
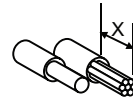

2 x 0.5..2.5mm<sup>2</sup>  
 2 x 18..12 AWG

1 x 0.5..2.5mm<sup>2</sup>  
 1 x 18..12 AWG

**Flexible with end sleeve**



2 x 0.5..2.5mm<sup>2</sup>  
 2 x 18..12AWG

1 x 0.5..2.5mm<sup>2</sup>  
 1 x 18..12AWG

**CONTROL CONNECTIONS: A1(+), A2(-) for RGH...MKE, MGE**

Use 60/75°C copper (Cu) conductors

**Stripping Length (X)**

12 - 13mm

**Rigid (Stranded)**

UL/ cUL rated data

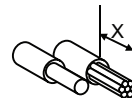

1 x 0.2...2.5mm<sup>2</sup>  
 1 x 24...12 AWG

Note: M5 PE screw not provided with SSR. PE connection required when product is intended to be used in Class 1 applications according to EN/IEC 61140.

## Installation Instructions

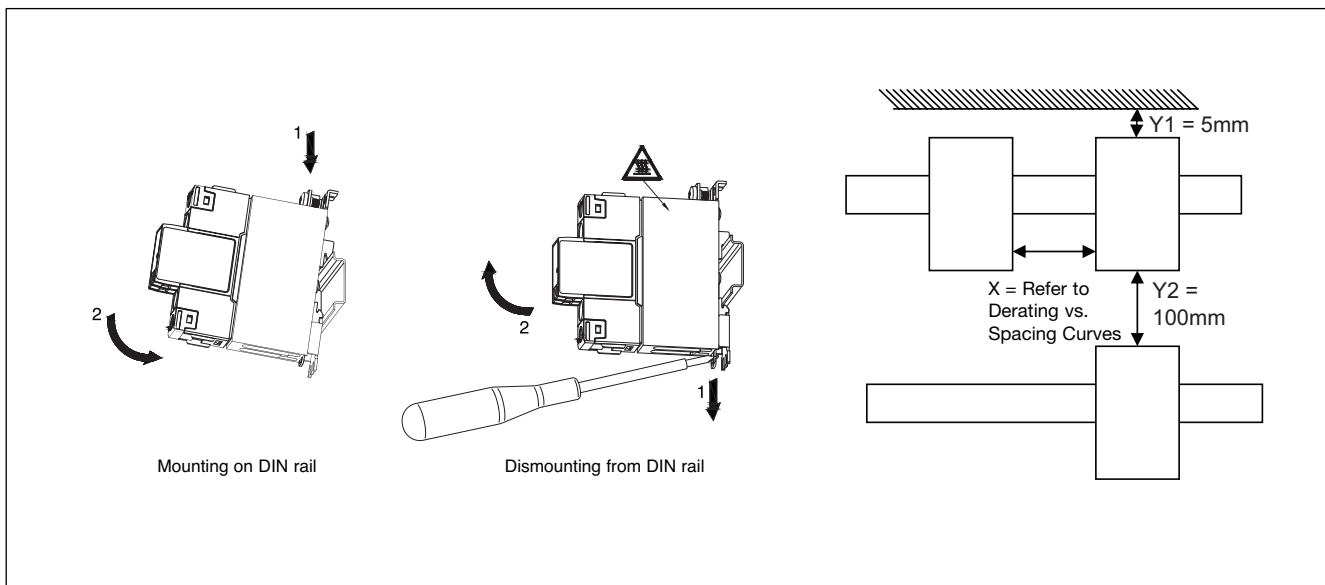

## Short Circuit Protection

### Protection Co-ordination, Type 1 vs Type 2:

Type 1 protection implies that after a short circuit, the device under test will no longer be in a functioning state. In type 2 co-ordination the device under test will still be functional after the short circuit. In both cases, however the short circuit has to be interrupted. The fuse between enclosure and supply shall not open. The door or cover of the enclosure shall not be blown open. There shall be no damage to conductors or terminals and the conductors shall not separate from terminals. There shall be no breakage or cracking of insulating bases to the extent that the integrity of the mounting of live parts is impaired. Discharge of parts or any risk of fire shall not occur.

The product variants listed in the table hereunder are suitable for use on a circuit capable of delivering not more than 100,000 A rms Symmetrical Amperes, 600 Volts maximum when protected by fuses. Tests at 100,000 A were performed with Class J fuses, fast acting; please refer to the table below for maximum allowed ampere rating of the fuse. Use fuses only.

### Co-ordination type 1 (UL508)

Part No.	Max. fuse size [A]	Class	Current [kA]	Voltage [VAC]
RGH..15	30	J	100	Max. 600
RGH..20	30	J	100	Max. 600
RGH..21	30	J	100	Max. 600
RGH..31	30	J	100	Max. 600
RGH..40	30	J	100	Max. 600
RGH..41	40	J	100	Max. 600
RGH..60	40	J	100	Max. 600

### Co-ordination type 2 (IEC EN 60947-4-2/ -4-3)

Part No.	Ferraz Shawmut		Siba		Current [kA]	Voltage [VAC]
	Max fuse size [A]	Part number	Max fuse size [A]	Part number		
RGH..15	100	A70QS100-4	100	50 194 20.100	100	Max. 600
RGH..20	50	A70QS50-4	-	-	100	Max. 600
RGH..21	100	A70QS100-4	100	50 194 20.100	100	Max. 600
RGH..31	100	A70QS100-4	100	50 194 20.100	100	Max. 600
RGH..40	50	A70QS50-4	-	-	100	Max. 600
RGH..41	100	A70QS100-4	100	50 194 20.100	100	Max. 600
RGH..60	100	A70QS100-4	100	50 194 20.100	100	Max. 600

## Protection with Miniature Circuit Breakers

Solid State Relay type	Model no. for Z - type M. C. B. (rated current)	Model no. for B - type M. C. B. (rated current)	Wire cross sectional area [mm <sup>2</sup> ]	Minimum length of Cu wire conductor [m] <sup>3</sup>	
RGH..20, RGH..40	S201 - Z10 (10A)	S201-B4 (4A)	1.0	7.6	
			1.5	11.4	
			2.5	19.0	
	S201 - Z16 (16A)	S201-B6 (6A)	1.0	5.2	
			1.5	7.8	
			2.5	13.0	
			4.0	20.8	
	S201 - Z20 (20A)	S201-B10 (10A)	1.5	12.6	
			2.5	21.0	
	S201 - Z25 (25A)	S201-B13 (13A)	2.5	25.0	
			4.0	40.0	
	S202 - Z25 (25A)	S202-B13 (13A)	2.5	19.0	
			4.0	30.4	
	RGH..15 RGH..21 RGH..31 RGH..41 RGH..60	S201 - Z20 (20A)	S201-B10 (10A)	1.5	4.2
				2.5	7.0
4.0				11.2	
S202 - Z20 (20A)	S202 - Z20 (20A)	S202-B10 (10A)	1.5	1.8	
			2.5	3.0	
			4.0	4.8	
	S201 - Z32 (32A)	S201-B16 (16A)	2.5	13.0	
			4.0	20.8	
			6.0	31.2	
	S202 - Z32 (32A)	S202-B16 (16A)	2.5	5.0	
			4.0	8.0	
			6.0	12.0	
			10.0	20.0	
	S202 - Z50 (50A)	S202-B25 (25A)	4.0	14.8	
			6.0	22.2	
10.0			37.0		

3. between MCB and Load (including return path which goes back to the mains).

Note: A prospective current of 6kA and a 230/400V power supply system is assumed for the above suggested specifications. For cables with different cross section than those mentioned above please consult Carlo Gavazzi's Technical Support Group.

## Accessories

---

### Control Plugs



### Ordering Key

---

Pack of 10 spring  
loaded control plugs

**RGM25**

\* Refer to 'Connection Specifications' section for further details.