

TECHNICAL DATA

Model	from 50 to 4000 mm
Measurement taken	Displacement / Speed
Position read sampling time (typical)	1 ms
Speed measurement range	min 0 .. 0,1 m/s max 0 .. 10 m/s
Accuracy speed	< 2% (in all F.S.)
Shock test DIN IEC68T2-27	100g - 11ms - single shock
Vibrations DIN IEC68T2-6	12g / 10...2000Hz
Displacement speed	≤10 m/s
Max. acceleration	≤ 100 m/s ² displacement
Resolution	INFINITE (only limited from the electrical noise)
Cursor (see note)	Sliding cursor Floating separate cursor
Working temperature	-30...+75°C
Storage temperature	-40...+100°C
Coefficient of temperature	0.005% F.S. / °C
Protection	IP67

Note: 1) For strokes > 2500 mt use sliding or floating cursors with max. distance of 4mm
2) For multi-cursor versions, the cursors have to work under the same distance and temperature conditions

ELECTRICAL DATA

	0,1...10,1V (W/Z)	
	0...10V (N)	
	-10...+10V (T)	4...20mA (E)
	-5...+5V (L)	0...20mA (B)
Output signal	24 Vdc ±20%	24 Vdc ±20%
Nominal power supply	(opt. 15V ±10%)	(opt. 15V ±10%)
Max. power ripple	1Vpp	1Vpp
Max. input	70mA	90mA
Output load	2KΩ	< 500Ω
Max. output ripple	< 5 mV pp	< 5 mV pp
Max. output value	10.6 V	25 mA
Electrical isolation	500 V	500 V
Protection against polarity inversion	Yes	Yes
Protection against overvoltage	Yes	Yes
Self-resetting internal fuse	Yes	Yes

Main characteristics

- Absolute transducer
- Contactless transducer for longer lifetime
- Strokes from 50 to 4000mm
- Quick plug-in through stainless steel connectors
- Sliding or floating magnetic cursor
- Direct analog output (mA/V) for displacement and speed
- Cursor position: single or double (minimal distance 75mm)
- Work temperature: -30...+75°C
- Resistance to vibration (DIN IEC68T2/6 12g)
- IP67 protection
- EMI CE compatibility (EN 50081-2 50082-1)
- Power supply 24Vdc ±20%
- Improved internal structure with security set screws

Contactless linear position transducer with magnetostrictive technology.

The absence of electrical contact on the cursor eliminates all wear and guarantees almost unlimited life.

Compact size for simple installation.

Full protection against outside agents for use in harsh environments with high contamination and presence of dust.

Excellent linearity, repeatability, resistance to mechanical vibrations and shocks.

MECHANICAL DIMENSIONS

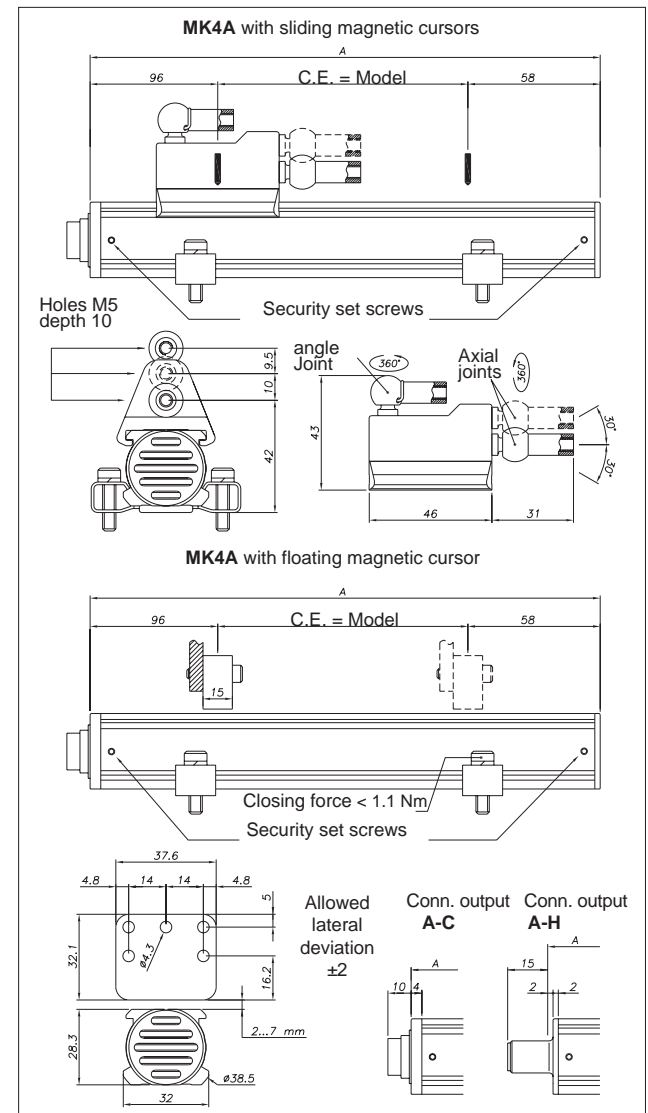

ELECTRICAL / MECHANICAL DATA

Model		50	75	100	130	150	175	200	225	250	300	350	360	400	450	500	550	600	650	700	750	800	850	900	950	1000	1100	1200	1250	1300	1400	1500					
																							1750	2000	2250	2500	2750	3000	3250	3500	3750	4000					
Electrical stroke (E.S.)	mm	Model																																			
Independent linearity	± % FS	typical 0,02 (Max. 0,04)																																			
Max. dimensions (A)	mm	Model + 152																																			
Repeatability	mm	< 0,01																																			
Hysteresis	mm	< 0,01																																			
Sampling time	ms	0,5 (1 for stroke from 300 to 1100) (1,5 for stroke from 1100 to 2000) (2 for stroke >2000) (3 for stroke >3000)																																			

ELECTRICAL CONNECTIONS

OUTPUT MK4A A

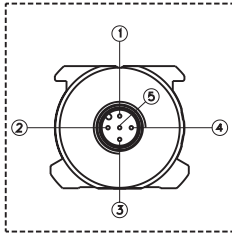

OUTPUT MK4A B

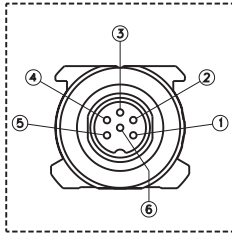

OUTPUT MK4A C

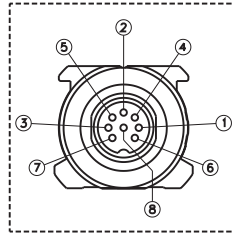

OUTPUT MK4A H

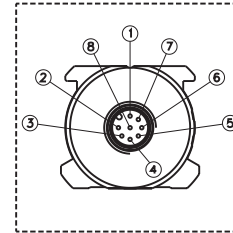

OUTPUT MK4A F

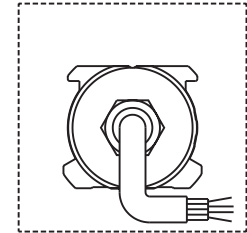

Function	CONNECTORS				CABLES	OPTIONAL CABLES FOR	
	MK4A-A 5 pin M12	MK4A-B 6 pin M16	MK4A-C 8 pin M16	MK4A-H 8 pin M12	MK4A-F Standard cable	MK4A-A pre-assembled 5 pin	MK4A-H pre-assembled 8 pin
Output cursor 1 0...10V 4...20mA 0...20mA -10...+10V -5...+5V	1	1	5 (1*)	5	Grey	Brown	Green
GND Output cursor 1 (0V)	2	2	2	1	Pink	White	Yellow
Inverse output cursor 1 Output cursor 2 Output speed 0...10V 4...20mA 0...20mA -10...+10V -5...+5V	3	3	3	3	Yellow	Blue	Pink
GND Output cursor 1 Output cursor 2 Output speed (0V)	2	4	6	2	Pink	White	Grey
Power supply+	5	5	7	7	Brown	Grey	Brown
Power supply GND	4	6	8	6	White	Black	Blue
n.c.	-	-	4	4	-	-	Red
n.c.	-	-	1(5*)	8	-	-	White

(*) = for version I 4...20mA / 0...20mA

The transducer case must be grounded with the cable sheathing on the control system side only.

CURRENT OUTPUT CONNECTION

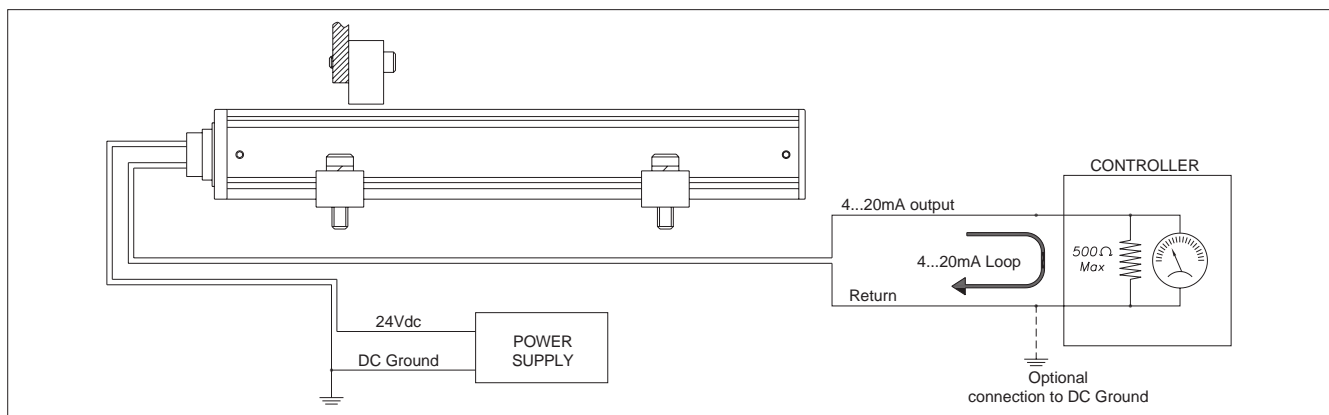

ANALOG OUTPUT MK4A

Series MK4A magnetostrictive transducers supply a direct analog voltage or current output proportional to 1 or 2 magnetic cursors position and displacement speed.

The output is also provided in reverse action.

Since the outputs are direct, no electronic processing of the signal is required if interfaced with controllers or measurement instruments.

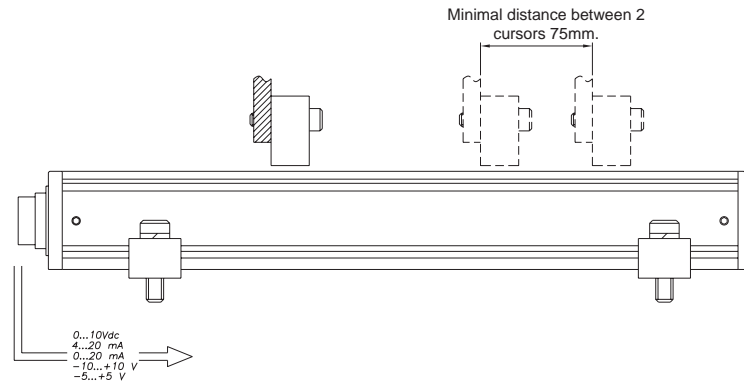

ORDER CODE

Position transducer **M K 4 A** [] [] [] [] [] []

Analog output **A**

Connector

M12 5-pin connector output **A**

Available on request

DIN45322 6-pin connector output **B**

DIN45326 8-pin connector output **C**

M12 8-pin connector output **H**

PVC cable output **F**

Model

Output		
0,1...10,1Vdc	1 cursor only for direct output	W
10,1...0,1Vdc	1 cursor only for inverse output	Z
0...10Vdc	1 cursor	N
0...10Vdc	1 cursor, position and speed	P
0...10Vdc	2 cursors (min. stroke 360mm)	Y
4...20mA	1 cursor	E
4...20mA	1 cursor, position and speed	F
4...20mA	2 cursors (min. stroke 360mm)	H
Available on request		
0...20mA	1 cursor	B
0...20mA	1 cursor, position and speed	C
0...20mA	2 cursors (min. stroke 360mm)	D
0...+5Vdc	1 cursor	K
-5...+5Vdc	1 cursor, position	L
-10...+10Vdc	1 cursor, position	T

0 0 0 0 X 0 0 0 X 0 0 X 0 X X

Output of speed

Only for analogic output option C, F, P

Maximum measurable speed: 0.1...10.0 m/s

00.0 Function not required

00	B, A, C, H Outputs
Output F cable length	
00	1 m
05	5 m
10	10 m
15	15 m

Mechanical and/or electrical characteristics differing from those in the standard version may be arranged on request.

Es.: **MK4-A-B-0400-N, PKIT090-02, PCUR035-01**

Transducer model MK4, analog output, 6-pin connector, model 400, 0...10Vdc output, n° 2 PKIT090 brackets, n°1 PCUR035 standard cursor.

CURSORS ON REQUEST

P C U R 0 1

Cursors

Sliding cursor , axial joint (low) (STANDARD)	035
Sliding cursor, axial joint (high)	036
Sliding cursor, angled joint	037
Floating Cursor	034

Number of cursors

PCUR035

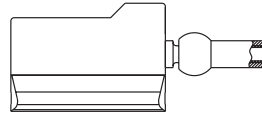

PCUR036

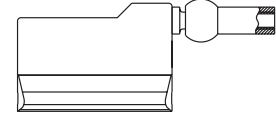

PCUR037

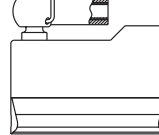

PCUR034

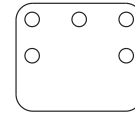

BRACKET S ON REQUEST

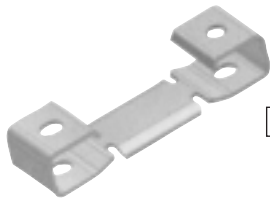

P K I T

Brackets (2 brackets for every kit)

Bracket in steel, interaxis 42.5mm	090
Bracket in steel, interaxis 50mm	091

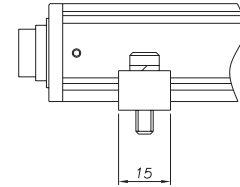
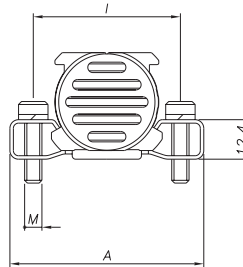

Brackets code	Interaxis (l)	Screw (V)	Dimension (A)
PKIT090	42.5	M4	56
PKIT091	50	M5	63.5

OPTIONAL FEMALE CONNECTORS

For A-H outputs, M12 thread connector

Code: **CON031** for 5-pin output (MK4A A)
CON041 for 5-pin output (MK4A A)
CON035 for 8-pin output (MK4A H)
CON042 for 8-pin output (MK4A H)

For B-C outputs, M16 thread connector

Code: **CON021** for 6-pin output (MK4A B)
CON022 for 6-pin output (MK4A B)
CON023 for 6-pin output (MK4A B)
CON026 for 8-pin output (MK4A C)
CON027 for 8-pin output (MK4A C)
CON028 for 8-pin output (MK4A C)

Connector extraction length: 10mm

Cable camp for ø6.5 cable

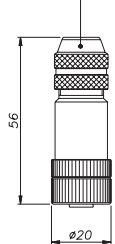

CON031
CON035
IP67 - IEC 48B

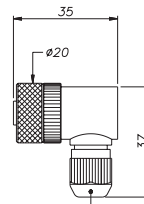

Cable camp for ø6 - ø8 cable

CON041
CON042
IP67

Cable camp for ø5 cable

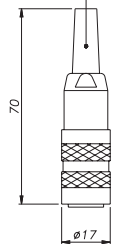

CON021
CON026
IP40 - EMC

Cable camp for ø6 - ø8 cable

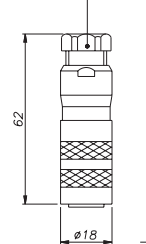

CON022
CON027
IP67 - EMC

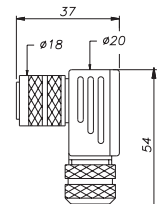

Cable camp for ø5 - ø8 cable

CON023
CON028
IP67 - EMC

OPTIONAL CABLES OUTPUT

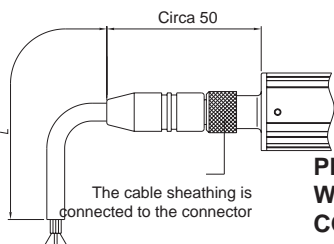

PRE-ASSEMBLED CABLE WITH STRAIGHT CONNECTOR

5-pin cable code		MK4A - A	
Length "L"		CODE	
		straight cable	Cable to 90°
2	mt	CAV011	CAV021
5	mt	CAV012	CAV022
10	mt	CAV013	CAV023
15	mt	CAV015	CAV024

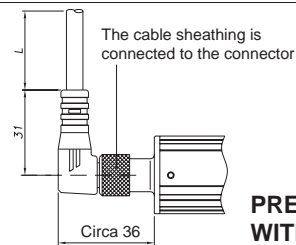

PRE-ASSEMBLED CABLE WITH 90° CONNECTOR

8-pin cable code		MK4A - H	
Length "L"		CODE	
		straight cable	Cable to 90°
2	mt	CAV002	CAV005
5	mt	CAV003	CAV006
10	mt	CAV004	CAV007
15	mt	CAV009	CAV008

GEFRAN spa
 via Sebina, 74
 25050 PROVAGLIO D'ISEO (BS) - ITALIA
 ph. 0309888.1 - fax. 0309839063
 Internet: <http://www.gefran.com>